

## CHAPTER - 11 SEATING ARRANGEMENTS

### VARIOUS PATTERN OF SITTING ARRANGEMENTS

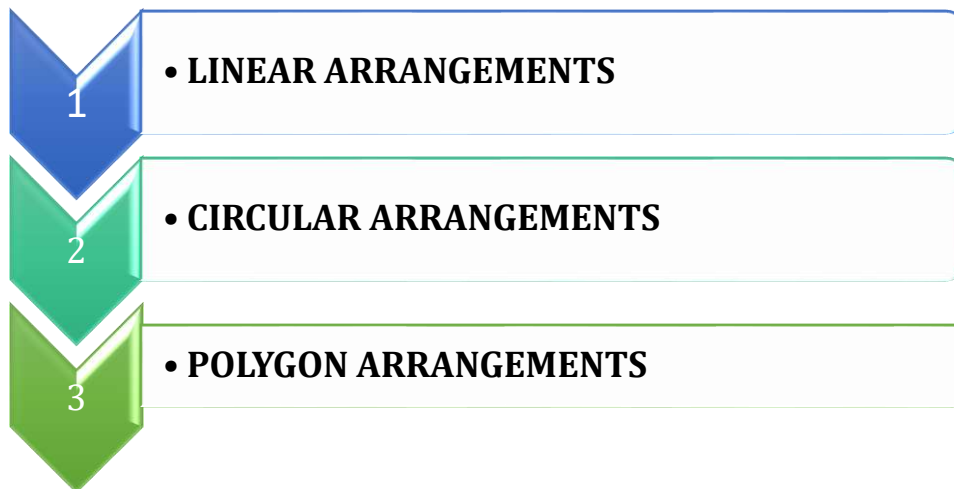

#### LINEAR ARRANGEMENTS

We arrange objects or persons in a line or row. The arrangement is done only on one 'axis' and hence, the position of persons or objects assumes importance in terms of order like positions. In this type of arrangement, we take directions according to our left and right.

One Row Sequence	When direction of face is not clear.
Two Row Sequence	When direction of face is clear at every level to each and every person.

#### Steps to Solve the Linear Arrangements:

- (a) Identify the number of objects and their names.
- (b) Use pictorial method to represent the people or objects and their positions.
- (c) Arrange the information with relevant facts and their positions and try to find out the solution.

## CIRCULAR ARRANGEMENT

(d) Answer the questions based on the arrangement having made. some persons are sitting around a circle and they are facing the center

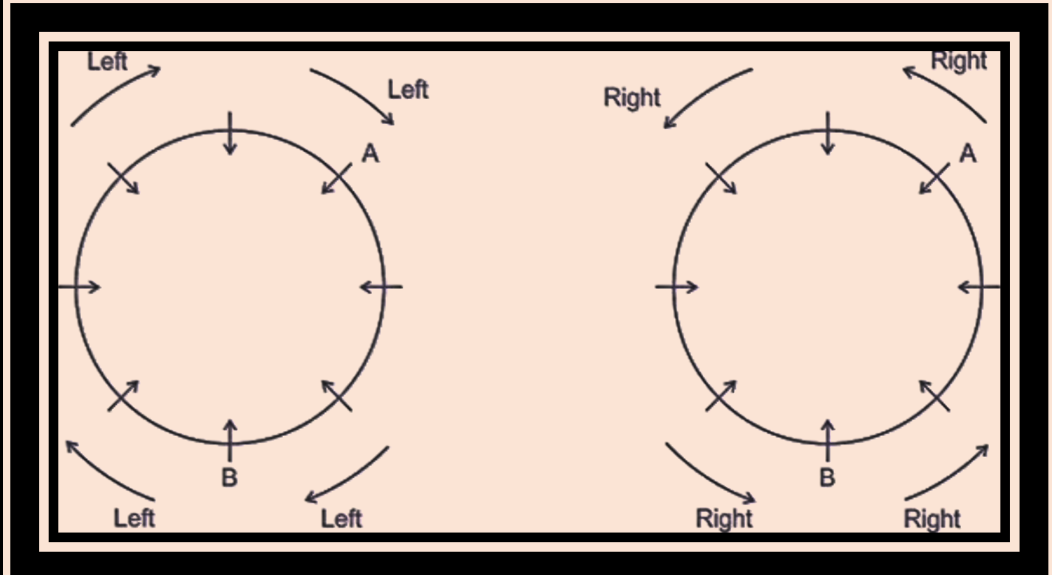

### Question 1

Four Children's are sitting in arrow. A is occupying seat next to B but not next to C. If C is not sitting next to D? Who is occupying seat next to adjacent to D.?

- (a) B (b) B and A  
(c) Impossible to tell (d) A

**Answer: D**

**Explanation:**

The arrangements as per given information is possible only if C is sitting next to B and D is sitting next to A.

Therefore, two possible arrangements are C, B, A, D, or D, A, B, C Clearly, only A is sitting adjacent to D

### Question 2

P, Q, R, S, T, U, V and W are sitting in a row facing North.

(a) P is fourth to the right of T

(b) W is fourth to the left of S

(c) R and U, which are not the ends are neighbours of Q and T

(d) W is next to the left of P and P is the neighbour of Q, who are sitting at the extreme ends

**Answer: A**

**Explanation:**

There are three persons between P and TXXXP.

In the information (iv), It is given that W is next to the left of P and Q is the neighbor of P. Using the information with (i), we get TXXWPQ.

### **Question 3**

**A, P, R, X, S and Z are sitting in a row. S and Z are in the centre. A and P are at the ends. R is sitting to the left of A. Who is to the right of P?**

a) A

b) X

c) S

d) Z

**Answer: B**

**Explanation:**

The seating arrangement is as follows:



Therefore, right of P is X

### **Question 4**

**A, B, C, D and E are sitting on a bench. A is sitting next to B, C is sitting next to D, D is not sitting with E who is on the left end of the bench. C is on the second position from the right. A is to the right of B and E. A and C are sitting together. In which position A is sitting?**

(a) Between B and D

(b) Between B and C

(c) Between E and D

(d) Between C and E

**Answer: B**

**Explanation:**

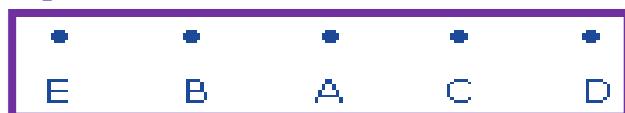

Therefore, A is sitting in between B and C

### **Question 5**

**P, Q, R, S, T, U, V and W are sitting round the circle and are facing the centre: P is second to the right of T who is the neighbour of R and V. S is not the neighbour of P.**

**V is the neighbour of U.**

**Q is not between S and W. W is not between U and S**

**According to this answer bellowed Questions:**

**5.1 Which two of the following are not neighbours?**

- (a) RV (b) UV  
(c) RP (d) QW

**Answer: A**

**Explanation:**

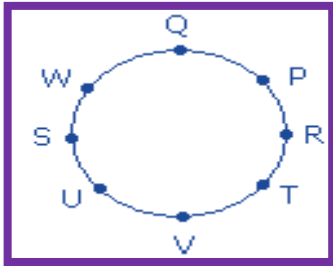

**5.2. Which one is immediate right to the V ?**

- (a) P (b) U  
(c) R (d) T

**Answer: D**

**Explanation:**

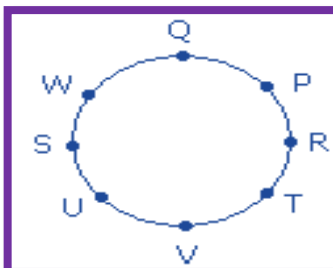

**5.3. Which of the following is correct?**

- (a) P is to the immediate right of Q (b) R is between U and V  
(c) Q is to the immediate left of W (d) U is between W and S

**Answer: C**

**Explanation:**

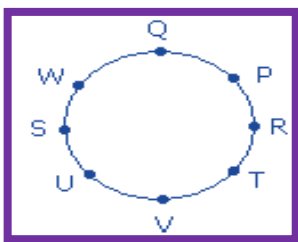

**5.4 What is the position of S?**

- (a) Between U and V  
(c) To the immediate right of W

- (b) Second to the right of P  
(d) Data inadequate

**Answer: C**

**Explanation:**

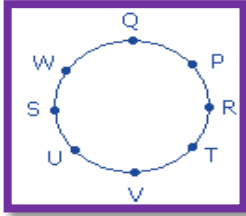

### **Question 6**

**6.1 Five girls are sitting on a bench to be photographed. Seema is to the left of Rani and to the right of Bindu. Mary is to the right of Rani. Reeta is between Rani and Mary. According to this answer bellowed Questions:**

**Who is sitting immediate right to Reeta?**

- (a) Bindu (b) Rani  
(c) Mary (d) Seema

**Answer:C**

**Explanation:**



Mary is sitting immediate right to Reeta.

**6.2 Who is in the middle of the photograph?**

- (a) Bindu (b) Rani  
(c) Reeta (d) Seema

**Answer: B**

**Explanation:**



Rani is in the middle of the photograph.

**6.3 Who is second from the right?**

- (a) Mary (b) Rani  
(c) Reeta (d) Bindu

**Answer: C**

**Explanation:**



Reeta is sitting second from the right.

#### 6.4. Who is second from the left in photograph?

- (a) Reeta (b) Mary  
(c) Bindu (d) Seema

**Answer: D**

**Explanation:**



Seema is sitting second from the left in photograph.

#### Question 7

Six friends are sitting in a circle and are facing the centre of the circle. Deepa is between Prakash and Pankaj. Priti is between Mukesh and Lalit. Prakash and Mukesh are opposite to each other.

#### 7.1. Who is sitting right to Prakash?

- (a) Mukesh (b) Deepa  
(c) Pankaj (d) Lalit

**Answer: D**

**Explanation:**

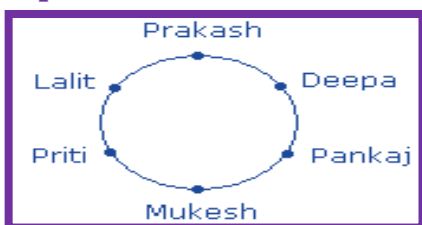

Hence, Lalit is sitting right to Prakash.

#### 7.2 Who is just right to Pankaj?

- (a) Deepa (b) Lalit  
(c) Prakash (d) Priti

**Answer: A**

**Explanation:**

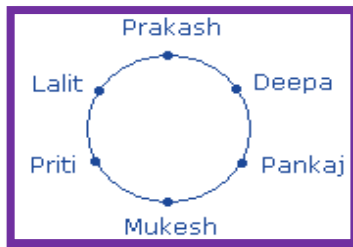

Hence, Deepa is sitting just right to Pankaj.

### 7.3 Who are the neighbours of Mukesh?

- (a) Prakash and Deepa  
 (b) Deepa and Priti  
 (c) Priti and Pankaj  
 (d) Lalit and Priti

**Answer:C**

**Explanation:**

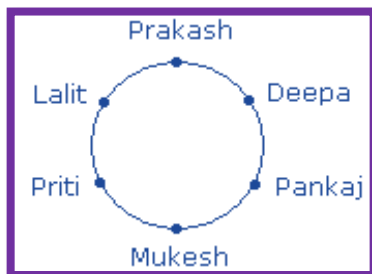

Hence, Priti and Pankaj are the neighbours of Mukesh.

### 7.4 Who is sitting opposite to Priti?

- (a) Prakash  
 (b) Deepa  
 (c) Pankaj  
 (d) Lalit

**Answer:B**

**Explanation:**

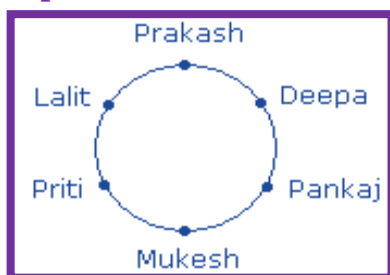

Hence, Deepa is sitting opposite to Priti.

### Question 8

**In an Exhibition seven cars of different companies - Cadillac, Ambassador, Fiat, Maruti, Mercedes, Bedford and Fargo are standing facing to east in the following order :**

**Cadillac is next to right of Fargo.**

**Fargo is fourth to the right of Fiat.**

**Maruti car is between Ambassador and Bedford.  
Fiat which is third to the left of Ambassador is at one end.**

**8.1 Which of the cars are on both the sides of Cadillac car?**

- (a) Ambassador and Maruti (b) Maruti and Fiat  
(c) Fargo and Mercedes (d) Ambassador and Fargo

**Answer:C**

**Explanation:**



Fargo and Mercedes are on both the sides of cadillac car.

**8.2 Which of the following statement is correct?**

- (a) Maruti is next left of Ambassador (b) Bedford is next left of Fiat.  
(c) Bedford is at one end. (d) Fiat is next second to the right of Maruti.

**Answer:A**

**Explanation:**

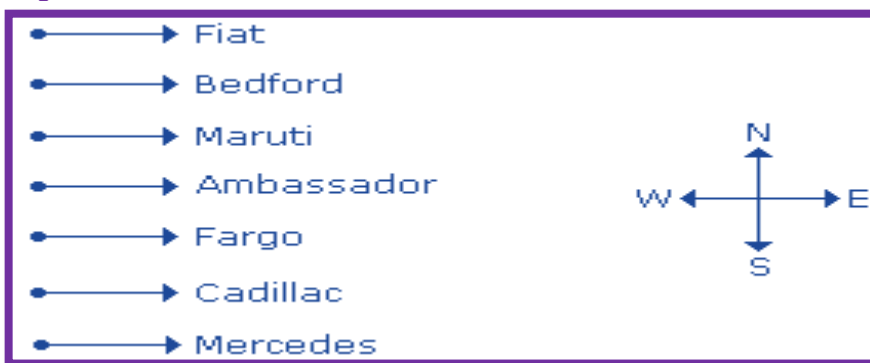

Therefore, Maruti is next left of Ambassador.

**8.3 Which one of the following statements is correct?**

- (a) Fargo car is in between Ambassador and Fiat (b) Cadillac is next left to Mercedes car.  
(c) Fargo is next right of Cadillac. (d) Maruti is fourth right of Mercedes

**Answer:B**

**Explanation:**





Therefore, Cadillac is next left to Mercedes car.

#### 8.4 Which of the following groups of cars is to the right of Ambassador?

- (a) Cadillac, Fargo and Maruti                      (b) Mercedes, Cadillac and Fargo  
 (c) Maruti, Bedford and Fiat                        (d) Bedford, Cadillac and Fargo

**Answer:B**

**Explanation:**

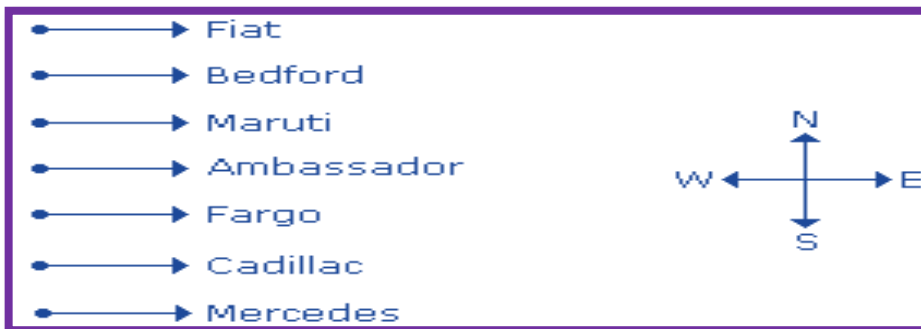

Mercedes, Cadillac and Fargo cars are to the right of Ambassador.

#### 8.5 Which one of the following is the correct position of Mercedes?

- (a) Next to the left of Cadillac                      (b) Next to the left of Bedford  
 (c) Between Bedford and Fargo                      (d) Fourth to the right of Maruti.

**Answer:D**

**Explanation:**

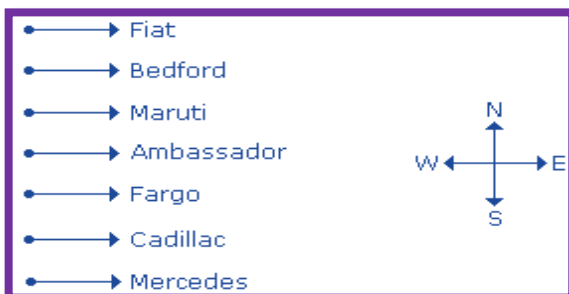

The correct position of Mercedes is fourth to the right of Maruti.

### Question 9

Six friends P, Q, R, S, T and U are sitting around the hexagonal table each at one corner and are facing the center of the hexagonal. P is second to the left of U. Q is neighbor of R and S. T is second to the left of S.

**9.1 Which one is sitting opposite to P?**

- (a) R (b) Q  
(c) Between Bedford and Fargo (d) Fourth to the right of Maruti.

**Answer: D**

**Explanation:**

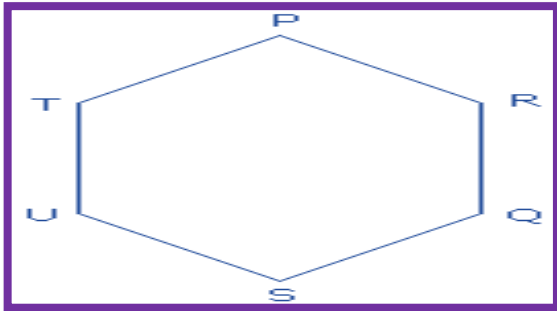

S is sitting opposite to P.

**9.2 Who is the fourth person to the left of Q?**

- (a) P (b) U  
(c) R (d) Data inadequate

**Answer: A**

**Explanation:**

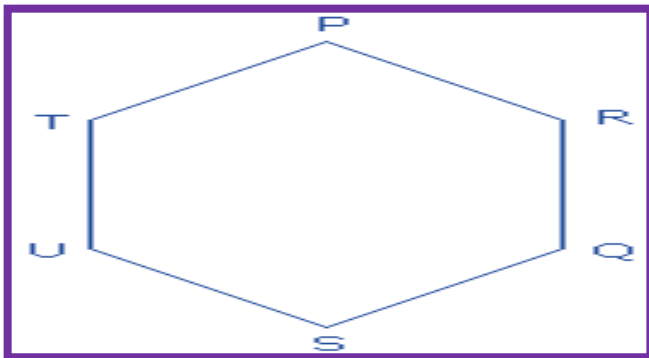

P is the fourth person to the left of Q.

**9.3 Which of the following are the neighbours of P ?**

- (a) U and P (b) T and R  
(c) U and R (d) Data inadequate

**Answer: B**

**Explanation:**

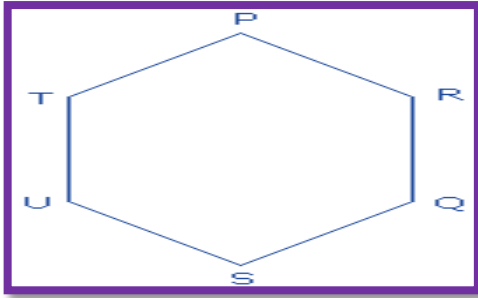

T and R are the neighbours of P.

#### 9.4. Which one is sitting opposite to T?

- (a) R (b) Q  
(c) Cannot be determined (d) S

**Answer: B**

**Explanation:**

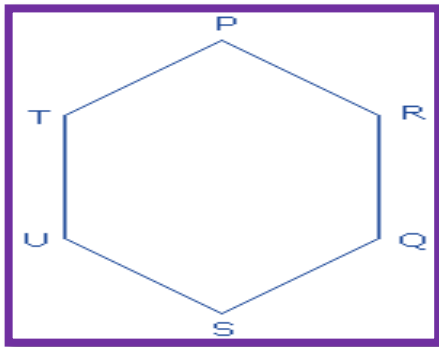

Q is sitting opposite to T.

#### Question 10

Each of these questions are based on the information given below:

A, B, C, D and E are five men sitting in a line facing to south - while M, N, O, P and Q are five ladies sitting in a second line parallel to the first line and are facing to North.

B who is just next to the left of D, is opposite to Q.

C and N are diagonally opposite to each other.

E is opposite to O who is just next right of M.

P who is just to the left of Q, is opposite to D.

M is at one end of the line

#### 10.1 Who is sitting third to the right of O?

- (a) Q (b) N  
(c) M (d) Data inadequate

**Answer: B**

**Explanation:**

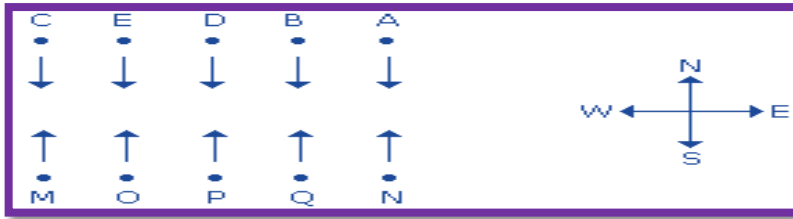

**10.2** If B shifts to the place of E, E shifts to the place of Q, and Q shifts to the place of B, then who will be the second to the left of the person opposite to O?

- (a) Q
- (b) P
- (c) E
- (d) D

**Answer: A**

**Explanation:**

Initial arrangement:

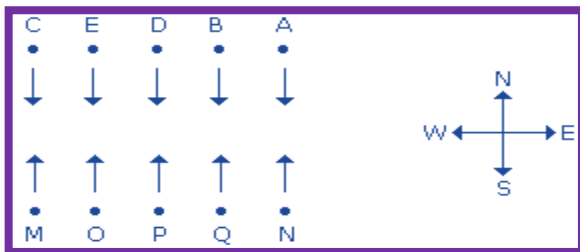

New arrangement after shifting:

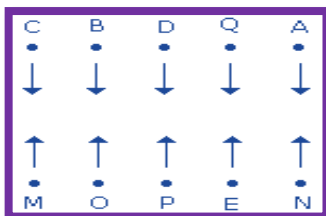

B is opposite to O and second person left to B is Q.

**10.3.** Which of the following pair is diagonally opposite to each other?

- (a) EQ
- (b) BO
- (c) AN
- (d) AM

**Answer: D**

**Explanation:**

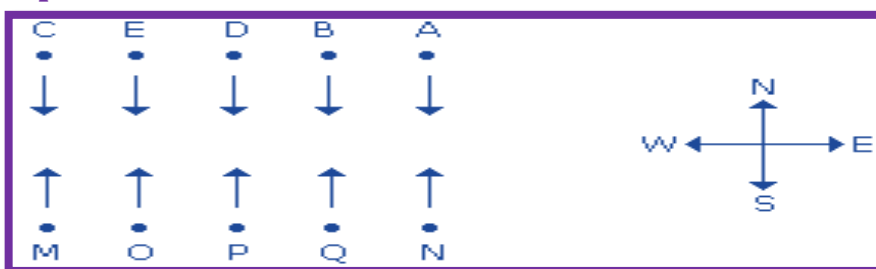

**10.4. If O and P, A and E and B and Q interchange their positions, then who will be the second person to the right of the person who is opposite to the person second of the right of P ?**

- (a) D
- (b) A
- (c) E
- (d) O

**Answer: B**

Explanation:

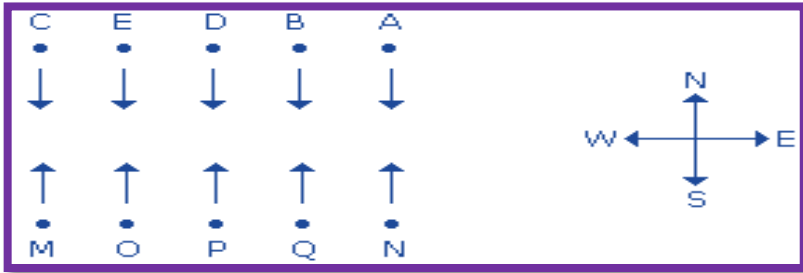

Old arrangement:

New arrangement:

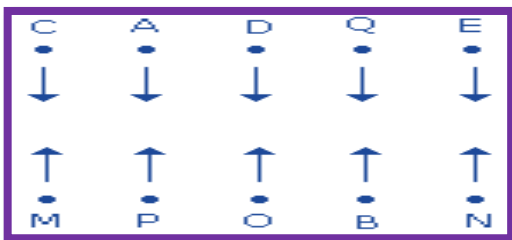

**Question 11**

**11.1 Who sits to the left of Shiksha?**

- (a) Rani
- (b) Radha
- (c) Chinu
- (d) Snigdha

**Answer: A**

Explanation:

After observation, we can conclude that the sitting arrangement is like this –

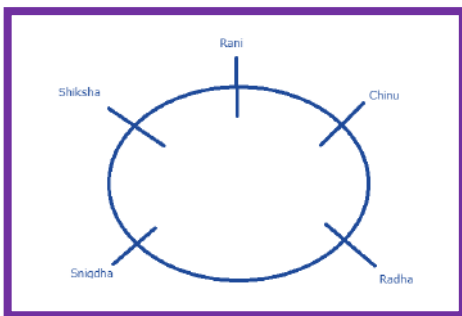

So, Rani sits to the left of Shiksha.

**11.2 If Radha and Snigdha change their places, then who will be second to the left of Rani?**

- (a) Radha
- (b) Snigdha
- (c) Shiksha
- (d) None of the above

**Answer: B**

**Explanation**

Second to the left of Rani will be Snigdha. Hence, option B is correct.

**11.3 How many girls are there in between Shiksha and Chinu if we count anti clockwise?**

- (a) 1
- (b) 2
- (c) 3
- (d) None of the above

**Answer: B**

**Explanation -**

Only two girls are there in between Shiksha and Chinu if we count anti clockwise?

**Question 12**

**12.1 What is the position of Major Batra?**

- (a) Major Batra is sitting between Major Kumar and Major Kalia.
- (b) Major Batra is sitting to the left of Major Kalia.
- (c) Major Batra is sitting to the immediate right of Major Kumar
- (d) All the above are true.

**Answer: D**

**Explanation -**

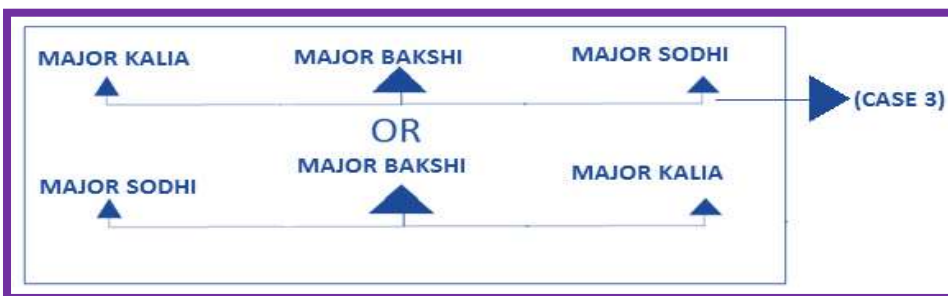

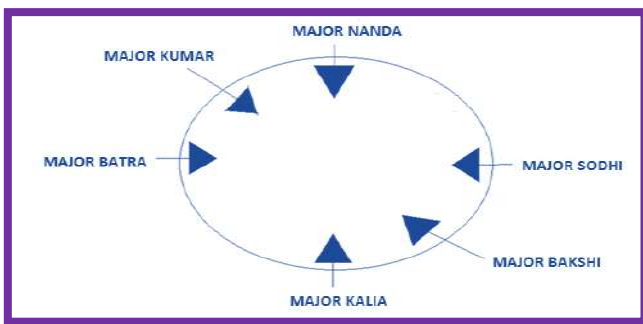
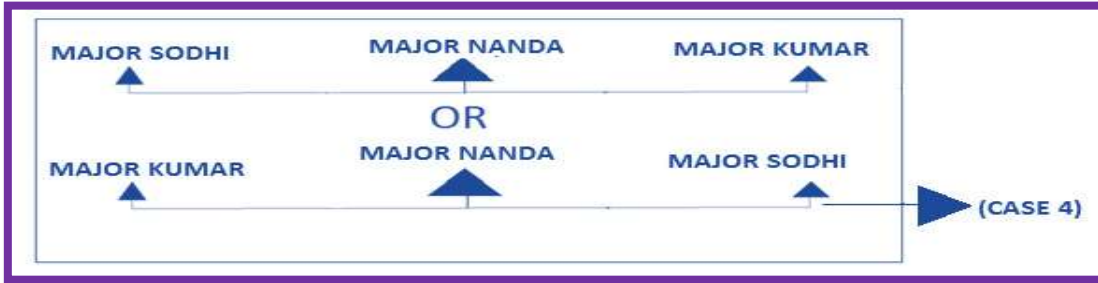

By applying (CASE 1), (CASE 2), (CASE 3) and (CASE 4), we get  
 All the options (A),(B) and (C) satisfy our condition. Therefore option (D) is correct.

**12.2 Who is sitting to the immediate left of Major Kumar?**

- (a) Major Bakshi
- (b) Major Batra
- (c) Major Nanda
- (d) Major Sodhi

**Answer: C**

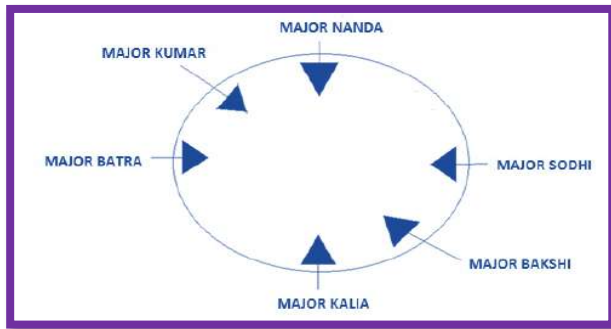
**Explanation:****According to the diagram –**

By observing the diagram, we can clearly say that Major Nanda is sitting to the immediate left of Major Kumar.

**12.3 Who is sitting to the immediate right of Major Kalia?**

- (a) Major Nanda  
(b) Major Kumar  
(c) Major Kalia  
(d) Major Bakshi

**Answer: D****Explanation –**

According to the diagram –

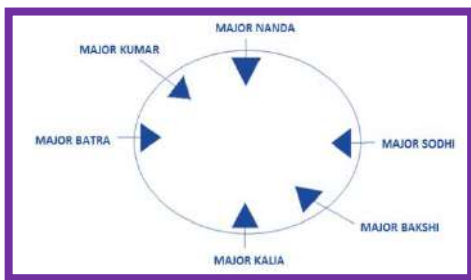

By observing the diagram, one can easily conclude that major Bakshi is sitting to the immediate right of Major Kalia.

**12.4 Which of the following statement is true?**

- (a) Major Sodhi is sitting second to the left of Major Bakshi.  
(b) Major Kalia is sitting between Major Nanda and Major Kumar  
(c) Major Batra is sitting to the left of Major Kalia  
(d) Major Nanda is sitting to the left of Major Kalia.

**Answer:C****Explanation –**

According to the diagram –



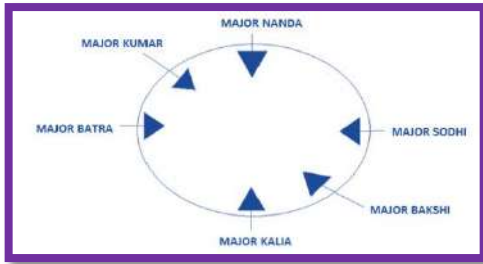

By observing the diagram, we can conclude that options (A), (B) and (D) do not satisfy the condition. But option (C) does.

**12.5 How many Majors are sitting between Major Sodhi and Major Kumar, if counted in clockwise direction?**

- (a) Six (b) Two  
(c) Three (d) Five

**Answer:C**

**Explanation -**

**According to the diagram -**

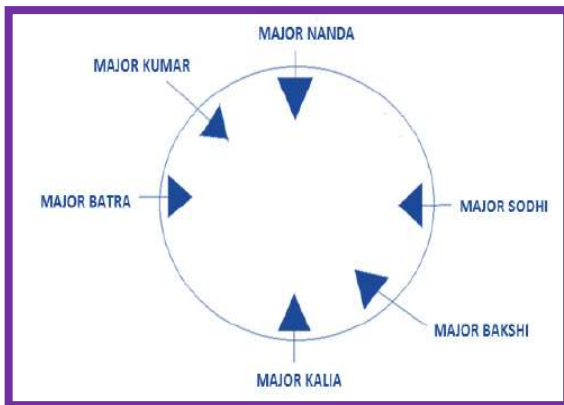

Major Bakshi, Major Kalia and Major Batra are the three majors sitting between Major Sodhi and Major Kumar.

**12.6 What is Major Batra position with respect to Major Sodhi?**

- (a) Second to the left (b) Immediate Right.  
(c) Fourth to the Right (d) Third to the left

**Answer: D**

**Explanation -**

**According to the diagram -**

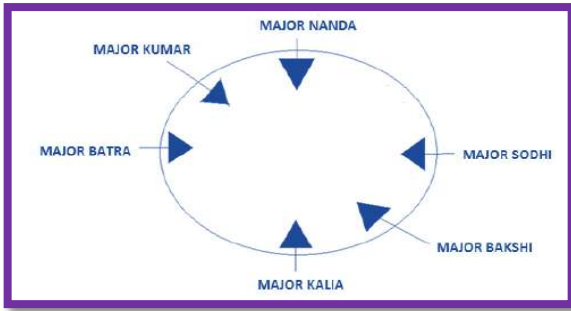

By observing the diagram, we can conclude that Major Bakshi is sitting to the immediate left of Major Sodhi. Major Kalia is sitting to the second left of Major Sodhi and Major Batra is sitting third to the left of Major Sodhi. So, our required answer is option (D).

**Question 13**

Study the given information carefully and answer the following questions. Four friends U, V, W and X are sitting in a row and facing towards north direction. U and X are sitting at two extreme ends. V is sitting between U and W. V is sitting second to the left of X.

13.1 Who is sitting to the immediate right of V?

- (a) X
- (b) U
- (c) W
- (d) None of these

**Answer: C**

**Explanation:**



According to the diagram –



By applying (CASE 1) and (CASE 2), we get



From the diagram, it is clear that W is sitting immediate right of V.

### 13.1 Who is sitting to the immediate left of X?

- (a) W (b) U  
(c) V (d) None of these

**Answer: A**

**Explanation -**

**According to the diagram -**



By observing the diagram, we can conclude that W is sitting immediate left of X.

### 13.2 What is the number of People sitting between X and U?

- (a) Three (b) Five  
(c) One (d) Two

**Answer: D**

**Explanation -**

**According to the diagram -**



By observing the diagram, we can conclude that V and W are the two people sitting between U and X.

### 13.3 Which statement is true?

- (a) X is sitting to the left of U (b) U and X are sitting at extreme ends.  
(c) U is sitting between V and X (d) Three people are sitting between U and X

**Answer: B**

**Explanation -**

**According to the diagram -**



U and X are the two people sitting at extreme ends whereas V is sitting to the right of U and W is sitting to the left of X.

### 13.4 Which of the following pairs is the first person sitting to the immediate right of second person?

- (a) VW (b) WV  
(c) UV (d) None of these

**Answer: B**

**Explanation -**

**According to the diagram -**



Here in option (B), the second person is V and the first person is W. So according to the condition, that is the first person sitting to the immediate right of the second person, only satisfies in option (B).

**13.5 How many persons are there to the right of U?**

- (a) Two (b) Four  
(c) One (d) Three

**Answer: D**

**Explanation -**

**According to the diagram -**



By observing the diagram, we can conclude that three-person V, W and X are sitting to the right of U.

### **Question 14**

**Study the following information carefully and answer the questions given below.**

**Certain number of people was sitting in a circle facing towards the Centre. Some of the person's arrangements are known. A was sitting fourth to the left of B. J was sitting seventh to the right of A. Number of person sitting between A and B was same as the number of persons sitting between A and F. J was the neighbor of D who sits at the seventh position from F (either left or right of F). Number of person sitting between F and M was same as the number of persons sitting between M and D. K was the neighbor of J. M is not the immediate neighbor of A.**

**14.1 What is the position of M with respect to A?**

- (a) Third to the left (b) Immediate right  
(c) Seventh to the right (d) Second to the right

**Answer: D**

**14.2 How many persons were sitting in a circle?**

- (a) 07
- (b) 08
- (c) 16
- (d) 19

**Answer: D**

**14.3. How many known persons were sitting between A and J when counted from left of A?**

- (a) Three
- (b) Four
- (c) Five
- (d) Two

**Answer: D**

**14.4. Who sits second to the right of B?**

- (a) K
- (b) F
- (c) A
- (d) J

**Answer: A**

**14.5 If C sits exactly between A and K when counted from right of A, then what is the position of C with respect to D?**

- (a) Fifth to the left
- (b) Fourteenth to the right
- (c) Sixteenth to the right
- (d) Either (a) or(b)

**Answer: D**

Explanation of Question 26 is:

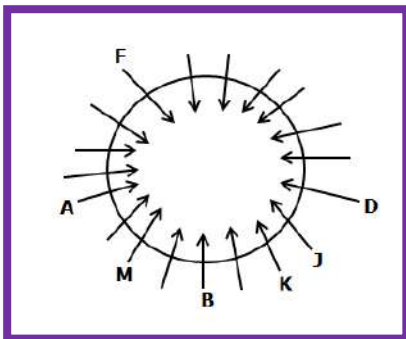

A certain number of people were sitting in a circle facing center.

A was sitting fourth to the left of B

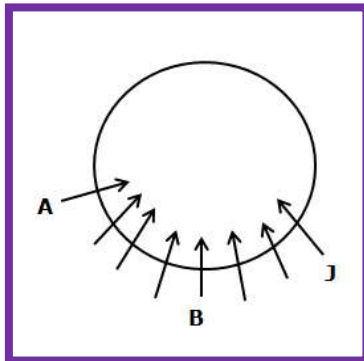
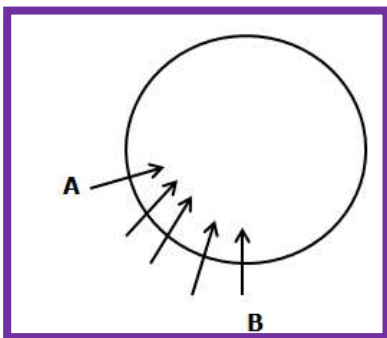

J was sitting seventh to the right of A.

Number of person sitting between A and B was same as the number of persons sitting between A and F.

J was the neighbor of D who sits at the seventh position from F (either left or right of F).

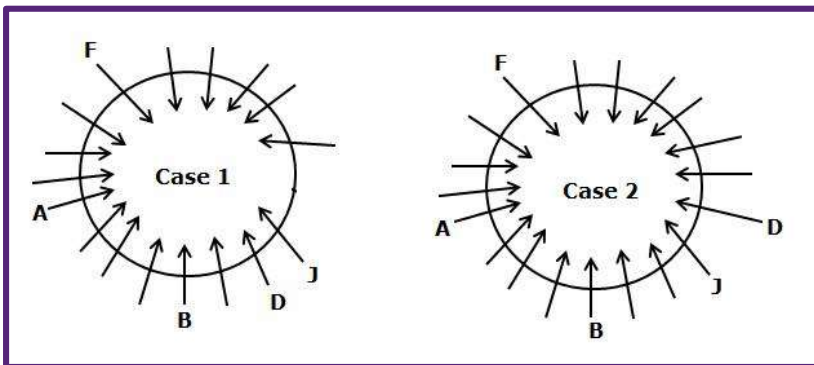
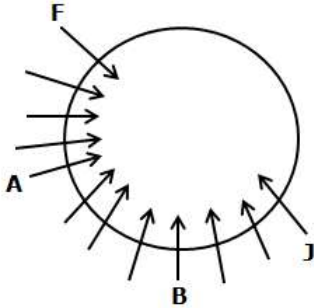

Number of person sitting between F and M was same as the number of persons sitting between M and D

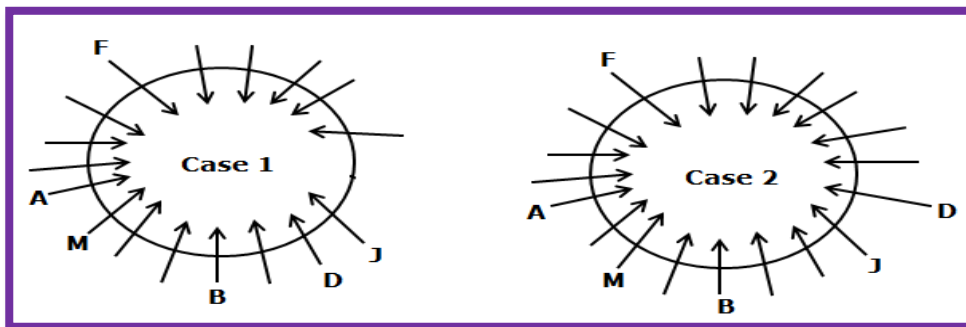

K was the neighbor of J.

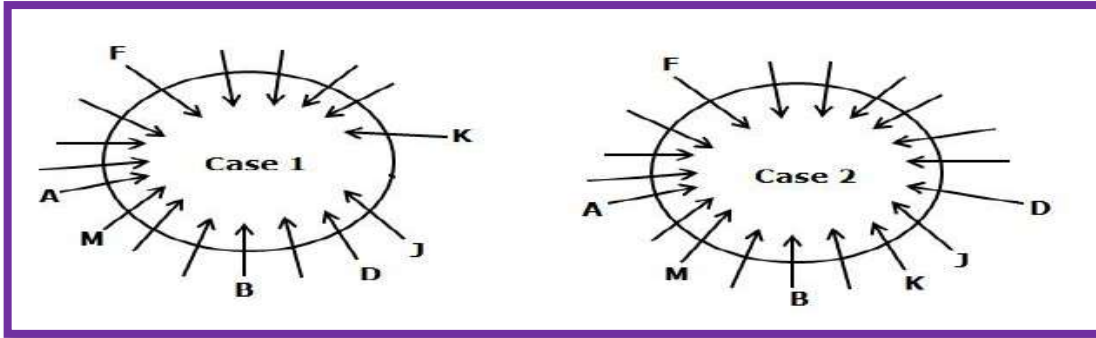

M is not the immediate neighbor of A. From this statement case 1 is eliminated because M and A are immediate neighbors.

**Question 15**

**Direction (27.1 to 27.5)** twelve persons A, B, C, D, E, F, P, Q, R, S, T and U are sitting in two parallel rows with equidistance from each other. In Row-1, A, B, C, D, E and F are sitting and all of them are facing south and in Row-2, P, Q, R, S, T and U are sitting and all of them are facing north but not necessary in the same order.

E sits second to the left of the one who faces P and either one of them sits at the extreme ends of the rows. Two persons are sitting between P and Q. F faces one of the immediate neighbour of Q. U faces the person the one who sits to the immediate right of A. Two persons are sitting between U and S. As many persons sitting to the right of T is same as the number of persons sitting to the right of C and neither of them sits at the extreme ends of the rows. R is not an immediate neighbour of S. C does not face Q. B sits one of the places to the left of E.

**15.1 Who sits diagonally opposite to S?**

- (a) B
- (b) A
- (c) D
- (d) F

**Answer: C**

**15.2 How many persons are sitting between T and P the one who faces D?**

- (a) None
- (b) One

(c) Two

(d) Three

**Answer: D**

**15.3 Four of the following five are alike in a certain way and hence form a group. Which one of the following that does not belong to the group?**

(a) Q

(b) P

(c) D

(d) S

**Answer: A**

**15.4 Which of the following statements is true?**

(a) Only two persons are sitting to the right of A

(b) U faces E

(c) Q sits exactly between T and R

(d) C sits at one of the extreme ends of the row

**Answer: B**

**15.5 If R is related to A and F is related to U in a certain way. Then, Q is related to which of the following?**

(a) C

(b) R

(c) E

(d) B

**Answer: D****Explanation:**

E sits second to the left of the one who faces P and either one of them sits at the extreme ends of the rows. Two persons are sitting between P and Q. F faces one of the immediate neighbors of Q.

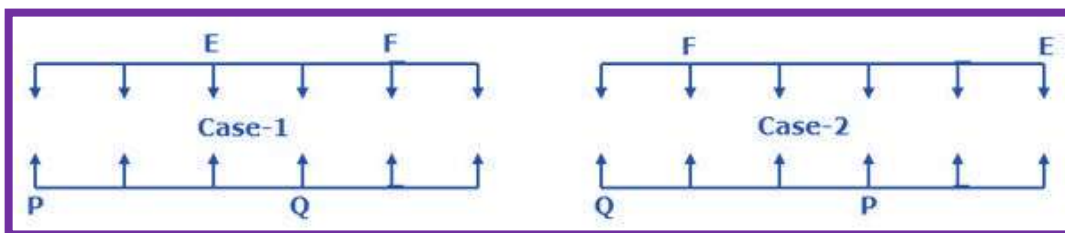

U faces the person the one who sits to the immediate right of A. Two persons are sitting between U and S.



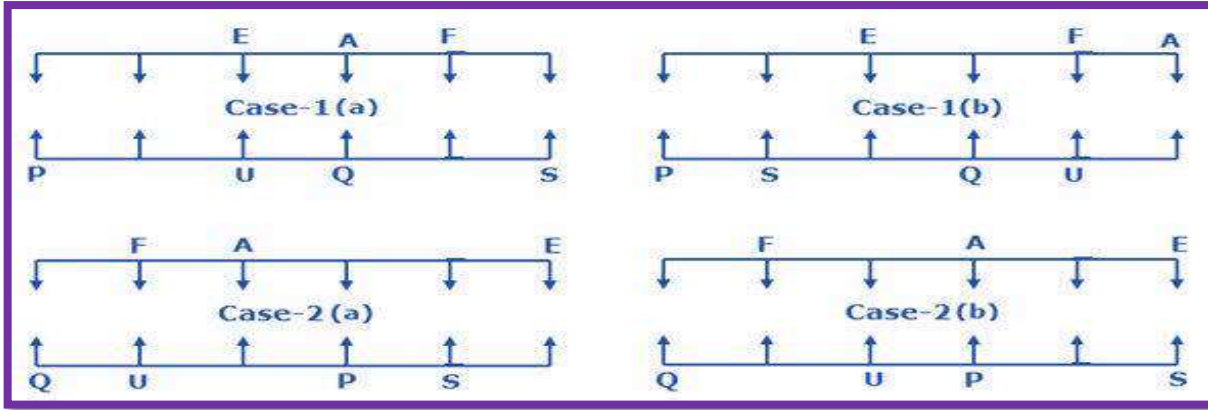

As many persons sitting to the right of T is same as the number of persons sitting to the right of C and neither of them sits at the extreme ends of the rows. R is not an immediate neighbor of S. C does not face Q.

So, Case-1(b), Case-2(a) and Case-2(b) will be dropped.

**B sits one of the places to the**

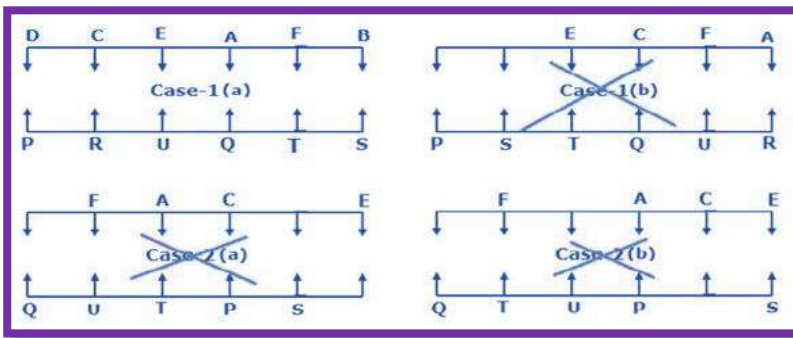

**Question 16**

**Direction (28.1 to 28.5):** Read the following information carefully and answer the questions given below. Eight persons P, Q, R, S, T, U, V and W are sitting in a square table such that four of them are sitting at the corners and remaining are sitting at the middle of each side. The persons who are sitting at the corners are facing towards centre of the table and the persons who are sitting at the middle of the sides are facing away from the centre of the table. R sits third to the left of T, who does not sit at one of the middle side of the table. Only one person sits between R and P (Either from right or left). Q sits second to the left of U and not an immediate neighbour of R. W sits opposite to S, who is not an immediate neighbour of P. More than one person's sit between W and R (Either from left or right)

**16.1** Who among the following persons sits third to the right of the one who sits to the immediate left of Q?

- (a) S
- (b) R
- (c) Q
- (d) P

**Answer: B**

**16.2 How many persons are sitting between P and T, when counted from left of T?**

- (a) Two (b) One  
(c) Four (d) Three

**Answer: C**

**16.3 b four of the following five are alike in a certain way and hence form a group. Which one of the following that does not belong to the group?**

- (a) V (b) P  
(c) U (d) R

**Answer: A**

**16.4 If R is related to Q and U is related to P in a certain way. Then, V is related to which of the following?**

- (a) W (b) S  
(c) R (d) T

**Answer: D**

**16.5 Which of the following statements is true?**

- (a) U sits second to the right of R (b) V sits at one of the corners  
(c) P sits opposite to T (d) W faces outside from the center

**Answer: B**

**Explanation:**

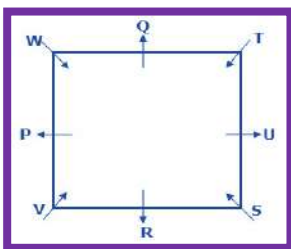

R sits third to the left of T, who does not sit at one of the middle of the sides. Only

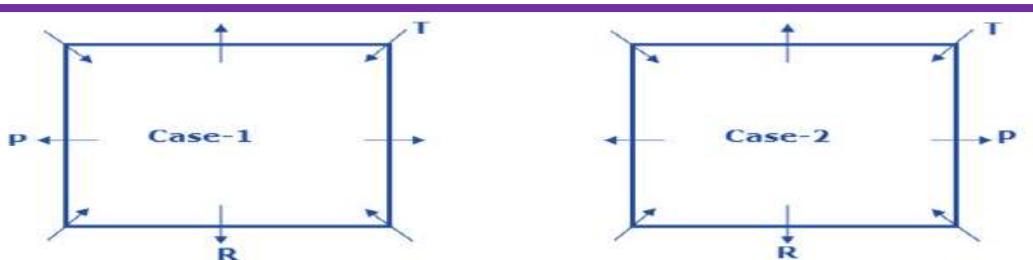

one person sits between R and P (Either from right or left).

Q sits second to the left of U and not an immediate neighbour of R.

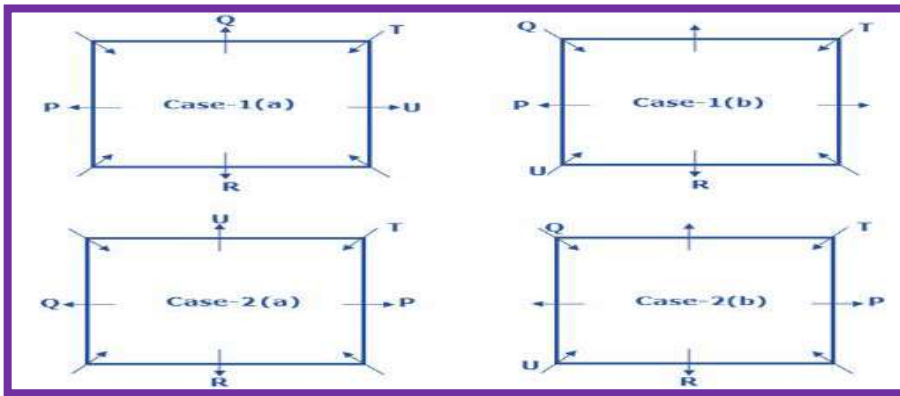

W sits opposite to S, who is not an immediate neighbour of P. More than one persons sit between W and R (Either from left or right). So, Case-1(b), Case-2(a) and Case-2(b) will be dropped.

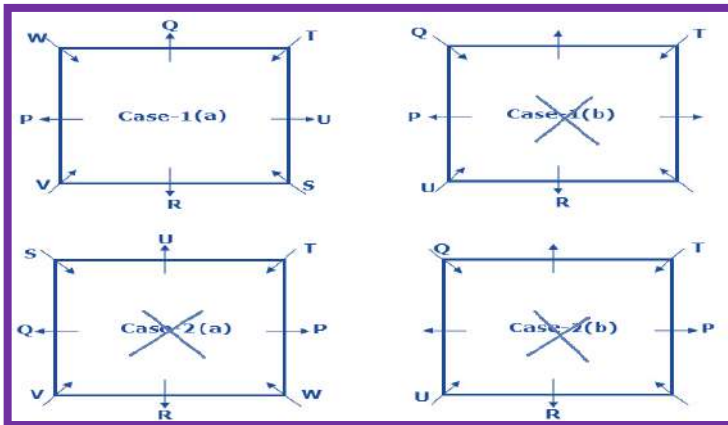

**Question 17**

**Direction (21-25):** Read the following information carefully and answer the questions given below.

A certain number of people sitting in the linear row facing north. Only three people sit between A and R. Only four people sit between K and W. Only five people sit between R and K. T sits third to the right of W. Only six people sit between R and Y. Not more than three people sit between K and Y. More than four people are between T and Y. Q sits third to the right of Y. None of them sits between Q and W. J sits eighth to the left of K. Not more than three persons sit between A and J.

**17.1** How many people are sitting in the line arrow?

- (a) Nineteen
- (b) Twenty
- (c) Twenty One
- (d) Twenty Two

**Answer: A**

**17.2 How many people sits between A and J?**

- (a) Seven
- (b) Three
- (c) Ten
- (d) One

**Answer: D**

**17.3 If three people sits between W and H, then which of the following statement is definitely true?**

- (a) Three people sit between T and H
- (b) W sits fourth to the right of H.
- (c) More than six people sit between Q and H.
- (d) More than five people sit between Y and H.

**Answer: D**

**17.4 How many people sits between Y and W?**

- (a) Sixteen
- (b) Three
- (c) Ten
- (d) Eight

**Answer: B**

**17.5 How many people sit to the left of K?**

- (a) Ten
- (b) Eight
- (c) Sixteen
- (d) Thirteen

**Answer: A**

**Explanation:**

i). Only three people sit between A and R.

ii). Only six people sit between R and Y.

Case (i): A \_\_\_\_\_ R \_\_\_\_\_ Y

Case (ii): Y \_\_\_\_\_ A \_\_\_\_\_ R

Case (iii): Y \_\_\_\_\_ R \_\_\_\_\_

\_\_\_\_\_ A Case (iv): R \_\_\_\_\_ A \_\_\_\_\_ Y

iii). Only five people sit between R and K. iv). Only four people sit between K and W.

v). T sits third to the right of W.

vi). Not more than three people sit between K and Y

Case (i): A \_\_\_\_\_ R \_\_\_\_\_ K Y

\_\_\_\_\_ W \_\_\_\_\_ T Case (ii)a: YK \_\_\_\_\_ A \_\_\_\_\_ WR

\_\_\_\_\_ T

Case (ii)b: W \_\_\_\_\_ TYK \_\_\_\_\_ A \_\_\_\_\_ R Case (iii)a: Y K

\_\_\_\_\_ WR \_\_\_\_\_ T \_\_\_\_\_ A

Case (iii)b: W \_\_\_\_\_ TY K \_\_\_\_\_  
 \_\_\_\_\_ R \_\_\_\_\_ A Case (iv)a: R \_\_\_\_\_ A  
 \_\_\_\_\_ KY \_\_\_\_\_ W \_\_\_\_\_ T Case

(iv)b: RW \_\_\_\_\_ A \_\_\_\_\_ K Y does not follow condition

(v) vii). More than four people are between T and Y.

viii). Q sits third to the right of Y. ix). None of them sits between Q and W.

x). Not more than three persons sit between A and J. xi). J sits eighth to the left of K.

Case (i): A \_\_\_\_\_ J \_\_\_\_\_ R \_\_\_\_\_ KY \_\_\_\_\_ QW \_\_\_\_\_ T

Case (ii) a: YK \_\_\_\_\_ A \_\_\_\_\_ WR \_\_\_\_\_ T = does not follow condition(viii)

Case (ii)b: W \_\_\_\_\_ TY K \_\_\_\_\_ A \_\_\_\_\_ R = does  
 not follow condition (vii) Case (iii)a: Y K \_\_\_\_\_ Q \_\_\_\_\_ WR \_\_\_\_\_ T \_\_\_\_\_  
 \_\_\_\_\_ A does not follow condition(ix)

Case (iii)b: W \_\_\_\_\_ TY K \_\_\_\_\_  
 \_\_\_\_\_ R \_\_\_\_\_ A does not follow condition (vii) Case (iv) a: J  
 \_\_\_\_\_ R \_\_\_\_\_ A \_\_\_\_\_ KY \_\_\_\_\_ QW \_\_\_\_\_  
 \_\_\_\_\_ T does not follow condition(x)

### **Question 18**

**Direction (30.1 to 30.5): Study following information carefully and answer the questions given below.**

**Seven friends- S, T, U, V, W, X and Y are sitting in a straight line. Some of them facing north and some of them are facing south.**

**Y faces north. Only two persons sit to the left of V. S sits second to the left of W. Only one person sits between S and**

**U. X sits third to the left of U. The immediate neighbours of S face the opposite directions. T is not an immediate neighbour of W. The immediate neighbours of U face same the directions. Only two persons sit between V and W. S faces the same direction as U. W sits to the immediate left of Y.**

**18.1 How many persons sit between Y and T?**

- (a) One (b) Two  
 (c) Three (d) None of these

**Answer: D**

**18.2 Four of the following five are alike in certain way and thus form a group as per the given arrangement. Which of the following does not belong to that group?**

- (a) X (b) T  
 (c) W (d) Y

**Answer: A**

**18.3 What is the position of V with respect to T?**

- (a) Second to the left
- (b) Fourth to the right
- (c) Immediate left
- (d) Second to the right

**Answer: D**

**18.4 How many persons face south directions?**

- a) Two
- b) Three
- c) Four
- d) Five

**Answer: B**

**18.5 Which of the following statement is correct?**

- (a) W sits at the extreme ends of the line
- (b) T faces south and sits to the immediate right of U
- (c) Only three person sits between Y and the one who sits second to the right of T
- (d) W faces north and sits second to the right of the one who sits immediate left of T

**Answer: C**

**Explanation:**

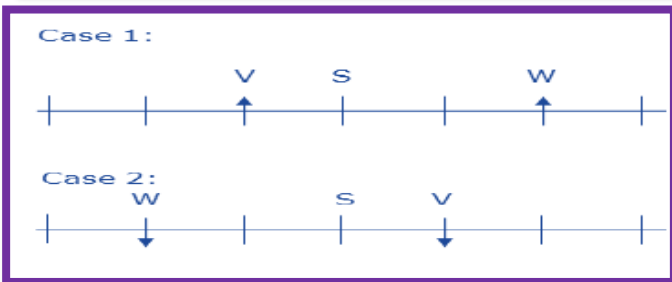

Only two persons sit to the left of V.  
 Only two persons sit between V and W.  
 S sits second to the left of W.  
 Now we have 2Cases.  
 The immediate neighbors of S face the opposite directions.

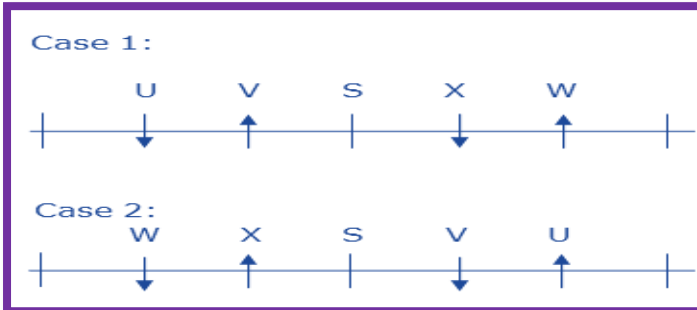
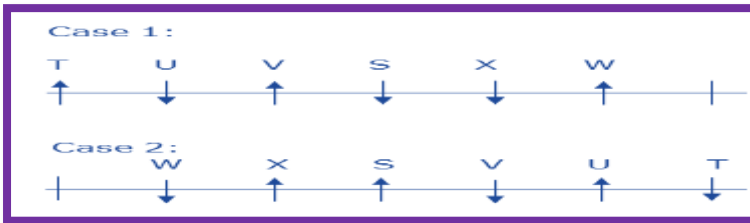

Only one person sits between S and U.  
 X sits third to the left of U  
 T is not an immediate neighbour of W.  
 The immediate neighbor of U faces same the directions.  
 S faces the same direction as U  
 W sits to the immediate left of Y.  
 Y faces north.  
 From the above condition Case 2 was dropped.  
 So the final arrangement is:

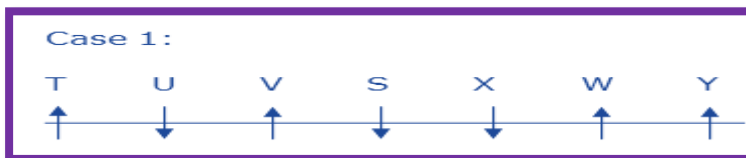

**Question 19**

**Direction (31.1 to 31.5):** Read the following information carefully and answer the questions given below.

**Eight persons are sitting in a circular table and all of them are facing away from the center of the table. V sits third to the right of M. Only one person sits between V and N (Either from right or left from V). K sits second to the left of G, who is not an immediate neighbour of M. As many persons are sitting between N and S is same as the number of persons sitting between R and S. T sits to the immediate right of R. T does not sit opposite to K.**

**19.1 Who among the following sits second to the right of S?**

- (a) R
- (b) T
- (c) N
- (d) G

**Answer: A**

**19.2 How many persons are sitting between G and V, when counted from left of G?**

- (a) Three
- (b) Four
- (c) One
- (d) Two

**Answer: D**

**19.3 Who among the following sits opposite to T?**

- (a) V
- (b) S
- (c) K
- (d) G

**Answer: D**

**19.4 Four of the following five are alike in a certain way and hence form a group. Which one of the following that does not belong to the group?**

- (a) TG
- (b) KM
- (c) MN
- (d) VS

**Answer: C**

**19.5 If all the persons in the final arrangement are made to sit in the alphabetical order as in the English alphabetical series from G in clock wise direction, then how many of them remains their original position (Excluding G)?**

- (a) None
- (b) One
- (c) Two
- (d) Three

**Answer: B**

**Explanation:**

V sits third to the right of M. Only one person sits between V and N (Either from

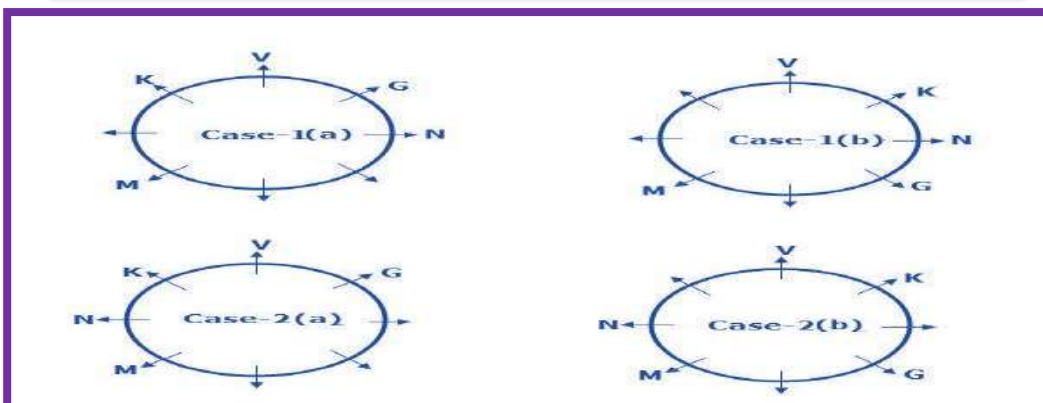
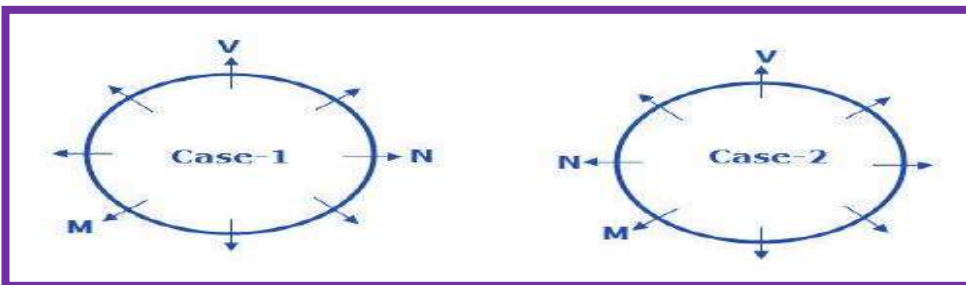



right or left from V).

K sits second to the left of G, who is not an immediate neighbour of M.

As many persons are sitting between N and S is same as the number of persons sitting between R and S. T sits to the immediate right of R.

So, Case-1(a) and Case-2(b) will be dropped.

T does not sit opposite to K.

So, Case-2(a) will be dropped

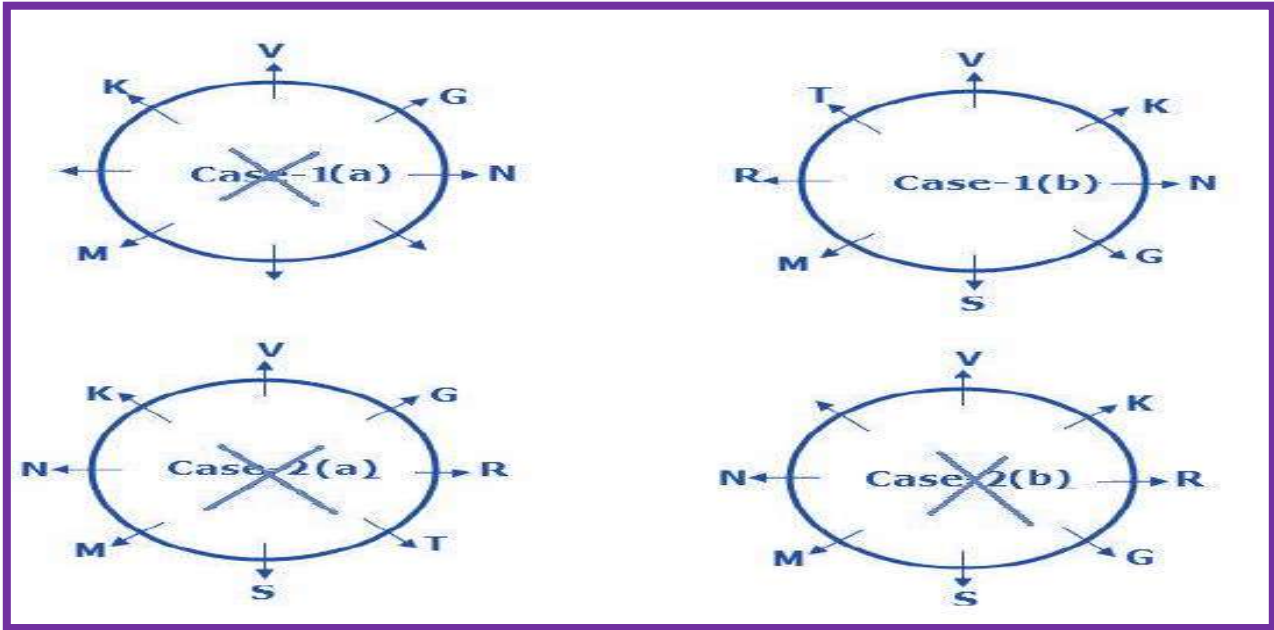

**Question 20**

**Direction (32.1 to 32.5):** study the given information carefully and the answer the following question below.

Ten persons are sitting in a parallel row. In Row 1 A, B, C, D and E are sitting in Row 1 facing north. In Row 2 P, Q, R, S and T are sitting in Row 2 facing south. The person in row 1 exactly faces the person in row 2.

R doesn't sits opposite to C. A sits second from the extreme end. Only one person sits between one who faces A and Q. B is not an immediate neighbour of A and doesn't sits opposite to Q. E sits second to the left of B. T doesn't faces E and never sits at extreme ends. S is not an immediate neighbor of T. C doesn't sits opposite to Q.

**20.1** Four of the five among the following are similar in the arrangement to form a group, which one of the following doesn't belongs to the group?

- (a) CA
- (b) ED
- (c) SQ
- (d) BD

**Answer: D**

**20.2 What is the position of A with respect to B?**

- (a) Third to the left
- (b) Third to the right
- (c) Second to the left
- (d) Immediate left

**Answer: A**

**20.3 Which of the following statement is not true?**

- (a) A sits to the immediate left of E
- (b) The one who sits opposite to D sits second to the left of T
- (c) C and B doesn't sit at the extreme ends
- (d) Q is the immediate neighbor of R and S

**Answer: C**

**20.4 Who sits second to the right of R?**

- (a) The one who sits opposite to A
- (b) S
- (c) P
- (d) None of these

**Answer: C**

**20.5 How many person sits between D and B?**

- (a) One
- (b) Two
- (c) Three
- (d) None

**Answer: D**

**Explanation:**

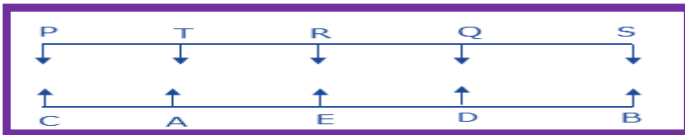

A sits second from the extreme end.



Only one person sits between one who faces A and Q.  
B is not an immediate neighbour of A and doesn't sit opposite to Q.



E sits second to the left of B.

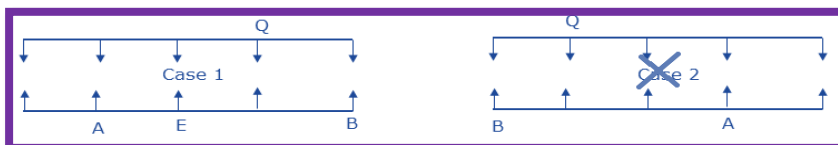

T doesn't faces E and never sits at extreme ends.  
 S is not an immediate neighbour of T.

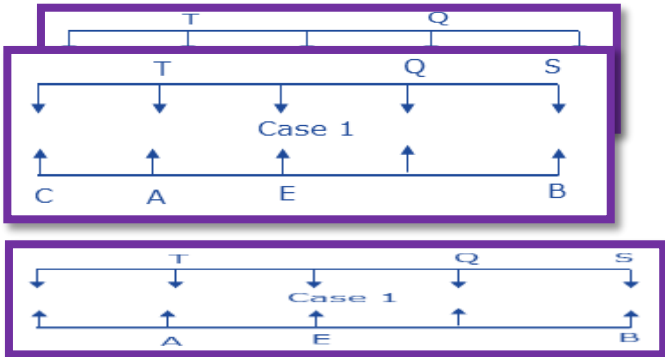

C doesn't sits opposite to Q.

R doesn't sits opposite to C.

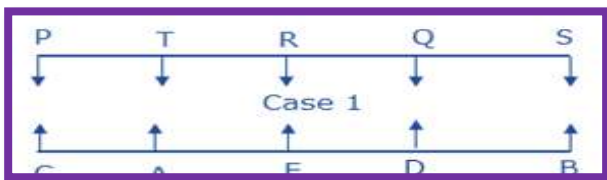

**Question 21**

**Direction (33.1 to 33.5):** Study following information carefully and answer the questions given below.

Eight friends – Sundar, Satya, Mark, Cook, Putin, Obama, Trump and Nitish are sitting around the circular table facing center, but not necessarily in the same order. Putin and Obama are not immediate neighbours. Only two persons sit between Sundar and Trump. Obama is not an immediate neighbour of Trump and Cook. Putin is not an immediate neighbour of Mark and Trump. Sundar sits second to the left of Cook. Nitish is not an immediate neighbour of Putin. Only three persons sit between Mark and Obama. Satya sits not opposite of Cook. Trump is not an immediate neighbour of Putin.

**21.1** What is the position of Cook with respect to Putin?

- (a) Third to the right
- (b) Second to the right
- (c) Immediate right
- (d) Fourth to the right

**Answer: C**

**21.2** How many persons sit between the one who sits the second to the left of cook and Mark, when counted from left of Mark?

- (a) One
- (b) Two

(c) Three

(d) No one

**Answer: B**

**21.3 Which of the following statement is incorrect?**

(a) Cook sits to the immediate left of Trump

(b) Only three persons sit between Satya and Sundar

(c) Sundar and Mark is an immediate neighbours

(d) Only one person sits between Nitish and the one who sits to the immediate left to Sundar

**Answer: C**

**21.4 What is the position of the one who sits second to the left of Sundar with respect to Trump?**

(a) Immediate right

(b) Fourth to the right

(c) Second to the right

(d) Second to the right

**Answer: A**

**21.5 Which of the following statement is correct?**

(a) Nitish sits to the immediate left of Obama

(b) Cook is an immediate neighbour of Satya

(c) Only two persons sit between Mark and Nitish when counted from left of Nitish

(d) Both a and c

**Answer: D**

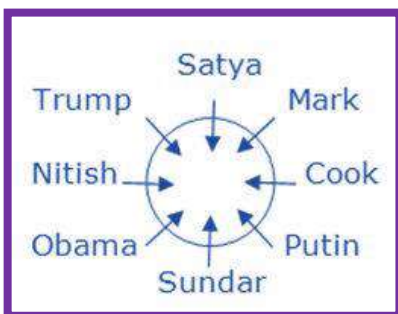

**Explanation:**

Only two persons sit between Sundar and Trump.

Sundar sits second to the left of Cook.

Now we have 2cases



Obama is not an immediate neighbour of Trump and Cook.  
Only three persons sit between Mark and Obama

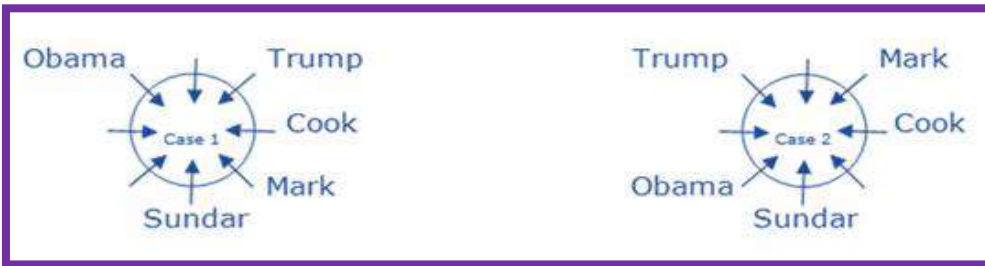

Putin is not an immediate neighbour of Mark and Trump.

Satya sits not opposite of Cook.

Putin and Obama are not immediate neighbours.

Nitish is not an immediate neighbor of Putin. Trump is not an immediate neighbor of Putin.

From the above condition Case 1 was dropped.

So the final arrangement is..



### Question 22

**Direction (34.1 to 34.5):** Read the following information carefully and answer the questions given below.

**Eight people I, J, K, L, M, N, O and P are sitting in a rectangular table. Only three persons are sitting in the longer side of the rectangle. The people sits at longer side of table faces outside the table, while the people sits at smaller side of the table faces inside the table. All the information is not necessary to be in the same order.**

**N sits second to the left of M. Only two persons sit between M and P, who is not an immediate neighbour of N. J sits immediate right of L. P sits opposite to I. Neither K nor L is an immediate neighbour of P. J sits second to the right of O and both are facing same direction. J does not sit opposite to O.**

**22.1 Name the person who sits opposite to J?**

- (a) M (b) O  
(c) N (d) I

**Answer: C**

**22.2 Who sits second to the left of P?**

- (a) L (b) K  
(c) J (d) O

**Answer: B****22.3 If all the people are made to sit in alphabetical order in clock wise direction from I, then how many of them remains in their original position?**

- (a) One (b) Two  
(c) Three (d) More than Three

**Answer: A****22.4 Name the person who sits second to the right of L?**

- (a) L (b) K  
(c) J (d) None of these

**Answer: D****Who sits fourth to the left of J?**

- (a) L (b) M  
(c) J (d) O

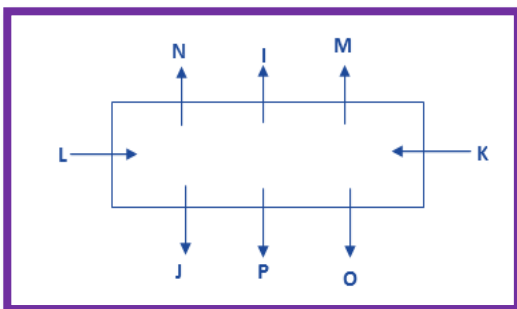
**Answer: B****Explanation:**

N sits second to the left of M.

Only two persons sit between M and P, who is not an immediate neighbour of N.

iii). P sits opposite to I.

Neither K nor L is an immediate neighbour of P.

J sits second to the right of O and both are facing same direction.

J does not sit opposite to O.

J sits immediate right of L.

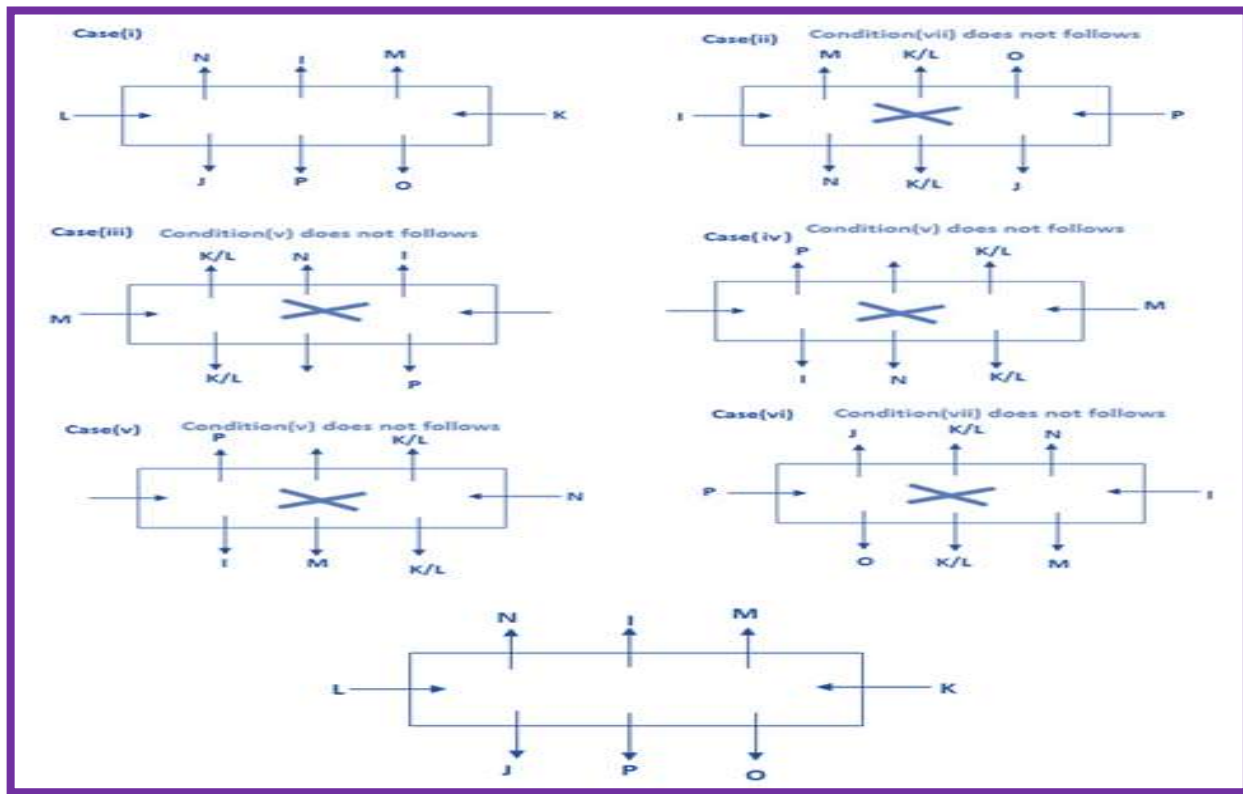

**Question 23**

**Direction (35.1 to 35.5):** Study the following information carefully to answer the given questions.

Six Students- Sita, Smita, Sunita, Sarita, Sujitha and Sneha lives on a building which has Six Floors with top floor numbered as 6. They got different Ranks from 1 to 6 in a School exam. They are also having different Lucky numbers from 1 to 6. These Six Students are also sitting in a row which has six seats and all are facing north. All students are having unique floor number, Lucky number, and Rank (i.e., No two numbers will be same for a particular student).

Students who sit at extreme ends of the row live neither on the top floor nor on the bottom floor. Sujitha lives on an even numbered floor. Sarita Floor number and Sita Lucky number are same. Two students live between Sita and Smita. Smita sits third to the left of Sujitha. One who lives on top floor sits third to the left of Sneha. A student whose Lucky number is 3 sits third to the right of the student whose lucky number is 5. Sita's Rank is 5. Two students live between Sujitha and Sarita. Smita Lucky number is same as Sita Floor number. Sunita Rank is 6 and she lives on an even numbered floor. Sneha's Rank is same as Sita's Lucky number. Sneha sits second to the right of Smita.

**Sneha's Lucky number is same as Sarita's Rank. Sujitha Rank is same as Sarita Lucky number.**

**23.1 Which of the following Pair is sitting at extreme ends?**

- (a) Sita and Sneha (b) Sunita and Sarita  
(c) Sujitha and Smita (d) Sunita and Sujitha

**Answer: D**

**23.2 Who among the following is living on Bottom Floor?**

- (a) Sarita (b) Smita  
(c) Sneha (d) Sita

**Answer: A**

**23.3 What is the Lucky number of Sita?**

- (a) One (b) Two  
(c) Three (d) Four

**Answer: A**

**23.4 Who among the following got Rank 2?**

- (a) Sita (b) Sneha  
(c) Smita (d) Sujitha

**Answer: C**

**23.5 Which of the following statement is false?**

- (a) Sita lives on top floor (b) Sneha's Rank is 1  
(c) Sujitha Lucky number is 2 (d) Sarita Rank is 3

**Answer: D**

**Explanation-**

Floor No	Rank	Lucky No	Person
6	5	1	Sita
5	1	4	Sneha
4	3	2	Sujitha
3	2	6	Smita
2	6	5	Sunita
1	4	3	Sarita





**Question 24**

**Direction (36.1 to 36.5):** Eight persons – A, B, C, D, E, F, G, and H are sitting in two rows having five seats in each row. In each row, one seat is vacant. Some of them are facing north and some are facing south.

Two persons are sitting between D and B. C sits opposite to D. G sits opposite to E. H sits opposite to the person who is sitting second to the left of F. F is not adjacent to E. Vacant seats are not opposite to each other. A, C and G face the same direction (i.e., All face either North or South). D, B, and E face the same direction (i.e., All face either North or South). C sits second to the right of E. H faces north. C doesn't sit at the extreme end. E sits second to the right of C. E sits to the adjacent left of H.

**24.1 How many persons are sitting between A and H?**

- (a) One (b) Two  
(c) Three (d) Four

**Answer: B**

**24.2 Who among the following pair is sitting opposite to vacant seats?**

- (a) A and D (b) B and A  
(c) C and F (d) A and F

**Answer: D**

**24.3 Who among the following is facing South?**

- (a) A (b) B  
(c) F (d) G

**Answer: C**

**24.4 Which of the following pair is sitting in the same row?**

- (a) A and D (b) C and F  
(c) E and B (d) B and F

**Answer: D**

**24.5 Which of the following statement is false based on above arrangement?**

- (a) A faces North (b) B sits at one of the extreme ends  
(c) D sits third to the right of B (d) Both the vacant seats are at extreme ends

**Answer: D**

**Explanation:**

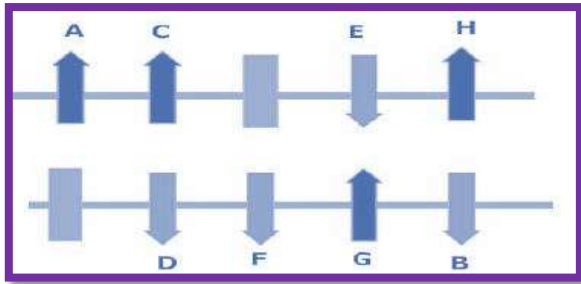

### Question 25

Study the following information carefully to answer the given questions.

Eight members P, Q, R, S, T, U, V and W of a family are sitting around a rectangular table with all of them facing outwards. Each one of them like different type of music instruments viz. XYLOPHONE, Balafon, Guitar, Piano, VIOLIN, TRUMPET, Accodions and Flute. Three married couples are there in the family.

W is the only sister-in-law of P whereas Q likes TRUMPET and daughter-in-law of RP who is the father of U and uncle of V, sits to the left of the person who likes XYLOPHONE. U is an immediate neighbor of her aunty W who does not sit next to S. R does not like Flute or Accodion. The two youngest members sit next to each other. The one who likes the Balafon sits between V and the one who likes VIOLIN. V is third to the left of S. The one who likes TRUMPET sits between the persons who like Accodion and Flute Respectively. S's husband and son sit next to her. Piano is not liked by V's father. V does not like Guitar or Accodion. S is the mother of P and T, and sits second to the left of T.

25.1 Which of the following statements is true regarding the family?

- |                           |                                 |
|---------------------------|---------------------------------|
| (a) P is the brother of W | (b) R is the father-in-law of P |
| (c) Q is the aunty of V   | (d) U and V are married couple  |

Answer: C

25.2 Who among the following sits between Q and the one who likes Balafon?

- |       |       |
|-------|-------|
| (a) P | (b) T |
| (c) S | (d) V |

Answer: D

25.3 What is the position of the person who likes Piano with respect to the one who likes TRUMPET?

- |                        |                        |
|------------------------|------------------------|
| (a) Third to the right | (b) Second to the left |
| (c) Immediate left     | (d) Third to the left  |

Answer: D

**25.4 Who among the following likes Guitar?**

- (a) W (b) U  
(c) V (d) T

**Answer: D****25.5 Which of the following options represent a pair?**

- (a) Y, X (b) W, T  
(c) W, R (d) S, U

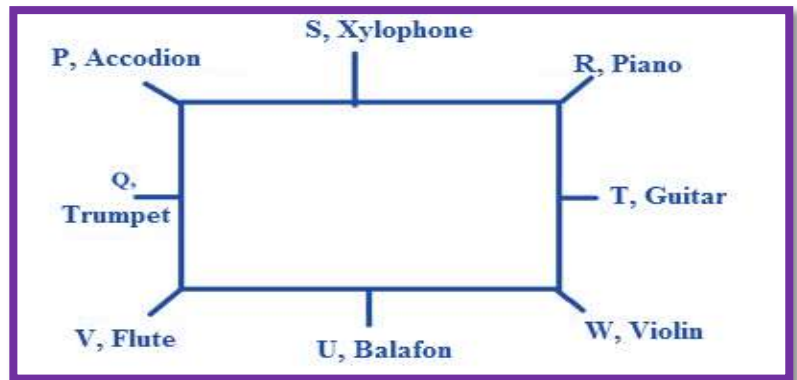
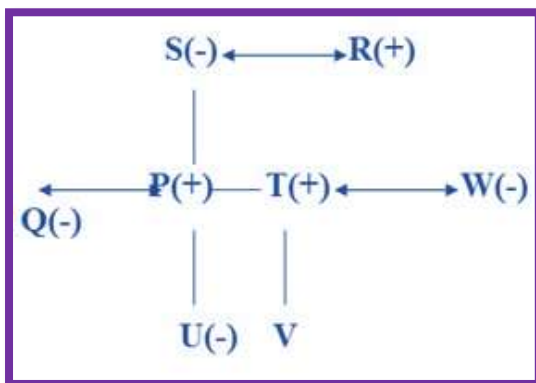
**Answer: B****Explanation-****Question 26**

Study the following information carefully to answer the given questions.

Eight players - P, Q, R, S, T, U, V and W sit around a square table in such a way that four of them sit on the four sides while the rest at corners. They play different instruments namely Xylophone, Balafon, Guitar, Piano, Violin, Trumpet, Accodion and Flute. Some of them are facing the centre while some are facing outside. (i.e away from the centre)

**Note:** Same directions means that if one person facing the centre then the other person also faces the centre and vice versa. Opposite direction means if one person is facing the centre then the other person faces outside and vice versa.

Q faces the centre of the table and does not sit on any corner. V sits on one of the corner between the Flute player and Trumpet player. W sits second to the right of Balafon player who faces the centre.

The Violin player sits third to the left of Q. S sits opposite to W. P sits on the corner exactly opposite to T. The Balafon player sits third to the right of Accodion player. The Xylophone player does not facing the centre.

The Trumpet sits opposite to Q, also faces in opposite direction of Q and sits between Accodion player and Violin player. T who is the Violin player sits immediate right to the Piano player.

The Piano player faces the same direction of the U. The immediate neighbours of Q are facing opposite directions. The Accodion player sits exactly opposite to Guitar player.

The one who is on the immediate left of U is facing the same direction as W. R sits third to the left of W.

**26.1 Who among the following is a Trumpet player?**

- (a) P (b) U  
(c) T (d) Can't be determined

**Answer: B**

**26.2 R is related to which of the following Instruments?**

- (a) Guitar (b) Xylophone  
(c) Accodion (d) Can't be determined

**Answer: A**

**26.3 Who among the following sits exactly between R and the Xylophone Player?**

- (a) The person who plays Flute (b) The person who plays Accodion  
(c) The person who plays Balafon (d) Trumpet

**Answer: C**

**26.4 How many persons sit facing the centre?**

- (a) None (b) One  
(c) Two (d) Four

**Answer: D**

**26.5 Which of the following pairs are the immediate neighbors of the Flute player?**

- (a) P, V (b) P, R  
(c) V, R (d) Q, R

**Answer: A**

**Explanation-**

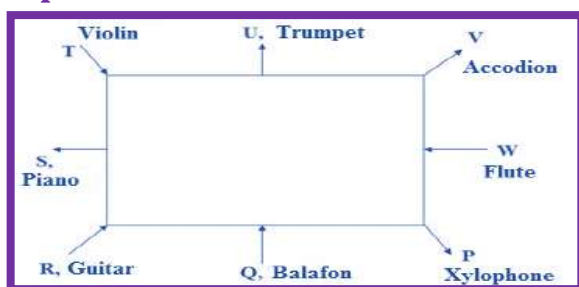

**Question 27**

Study the following information carefully to answer the given questions. There are 16 persons – B,C,D,E,F,G,H,I,P,Q,R,S,T,U,V and W standing in a square plot. Inside a Square plot, a square shaped garden is developed. The persons who are standing inside the garden facing outside. The persons who are standing outside the garden facing inside the centre and likes colours namely viz., – Red, Blue, Black, Brown, Yellow, Green, Violate and Pink. So all the persons standing in the inner square faces the persons standing in the outer Square and likes fruits namely viz., – Apple, Orange, Mango, Grapes, Papaya, Pomegranate, Guava and Banana.

G faces the centre and W faces G. D sits second to the right of G. There are four persons sits between G and E. D is not an immediate neighbour of E. There are three persons standing between I and E. There are two persons standing between I and B. B stands exactly between the E and F. F stands to the immediate left of G. There are two persons standing between W and U. U faces H. T faces outside. There are two persons standing between T and Q. T faces C. Q stands to the immediate left of W. R, the one who faces B stands exactly between the persons P and V. P faces E. The one who sits in the corner of the square likes Red. The one who likes Red sits between the persons who like Black and Blue. The one who likes Blue sits second to the right of the person who likes Green. Three persons sit between one who likes Black and one who likes Green. Two persons sit between one who likes Black and one who likes Yellow. Two persons sit between one who likes Yellow and one who likes Pink. G and F do not like Violate and Yellow respectively. The one who likes Red faces P. The immediate neighbours of P are the one who likes apple and the one who likes Grapes. The one who likes Apple faces the one who likes Black. Three persons sit between the one who likes apple and the one who likes Guava. The immediate neighbours of the person who likes Orange are the one who likes apple and the one who likes Pomegranate. The one who likes Papaya sits exactly behind to the one who likes Orange. The one who likes Banana sits exactly behind to the one who likes Mango. The one who likes Banana faces E.

**27.1** In the given arrangement, if three people come and stand to the immediate left of E, how many people will sit between F (From the left of F) and C?

- |          |                    |
|----------|--------------------|
| (a) Two  | (b) Three          |
| (c) Five | (d) More than four |

**Answer: C**

**27.2** Who amongst the following likes Green?

- |                               |       |
|-------------------------------|-------|
| (a) C                         | (b) B |
| (c) Other than those given as | (d) D |

options

**Answer:D**

**27.3 How many people stand between V and U?**

- (a) Two
- (b) Three
- (c) Four
- (d) More than four

**Answer: B**

**27.4 Four of the following five are alike in a certain way based upon their arrangement and so form a group. Which of the following does not belong to the group?**

- (a) FV
- (b) UH
- (c) EP
- (d) GW

**Answer: D**

**27.5 Who amongst the following likes Papaya?**

- (a) P
- (b) U
- (c) Q
- (d) E

**Answer: B**

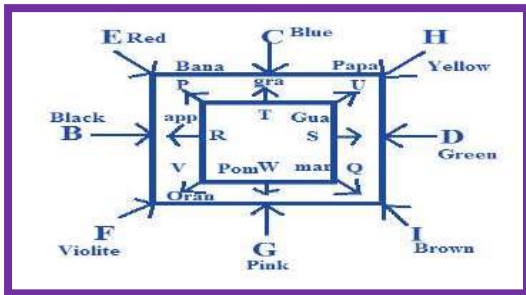

Explanation-

**Question 28**

Study the following information carefully to answer the given questions. There are 16 persons – B,C,D,E,F,G,H,I,P,Q,R,S,T,U,V and W standing in a Circular plot. Inside a circular plot, a circularly shaped garden is developed. The persons who are standing inside the garden facing outside. The persons who are standing outside the garden facing inside the centre and lives in a different number of floors. So all the persons standing in the inner circle faces the persons standing in the outer circle and hold a different number of chocolates.

G faces outside and S faces G. D sits immediate right of G. There are four persons sits between G and E. H is not an immediate neighbour of E. There are two persons standing between D and H. H faces R. There are three persons standing between R and U. U stands exactly between the B and F. B

faces D. There are two persons standing between P and C. Neither S nor R is an immediate neighbour of P. I stands to the immediate left of H. I faces T. The one who faces F stands exactly between the persons Q and W. W faces P. H stands second to the left of G. B lives on the second floor and sits exactly opposite to the person who lives on the floor which is the square number of the floor of B. F lives on the third floor and stands exactly opposite to the person who lives on the floor which is the square number of the floor of F. P lives on 6th floor and S lives immediately above P. U lives immediately below B. R lives immediately above T. The one who faces P holds chocolates two less than the number of the floor occupied by P. The one who faces U holds chocolates six more than the number of the floor occupied by U. Number of chocolates hold by E is the difference between the number of chocolates hold by D and W. Number of chocolates hold by G is the sum of the number of chocolates hold by D and E also equals to number of chocolates hold by V and H. Number of chocolates hold by I is the square of the number of chocolates hold by H.

**28.1 In the given arrangement, how many people will sit between B and T?**

- (a) Five (b) Three  
(c) Four (d) More than four

**Answer: B**

**28.2 Who amongst the following lives on the seventh floor?**

- (a) S (b) Q  
(c) Other than those given as options (d) U

**Answer: A**

**28.3 If persons counted from the right of G, then how many people stand between G and E as per the given arrangement?**

- (a) Five (b) Three  
(c) Four (d) Two

**Answer: D**

**28.4 Four of the following five are alike in a certain way based upon their seating arrangement and so form a group. Which of the following does not belong to the group?**

- (a) F (b) E  
(c) C (d) G

**Answer: D**

**28.5 Who amongst the following have seven chocolates?**

(a) T

(b) F

(c) Q

(d) P

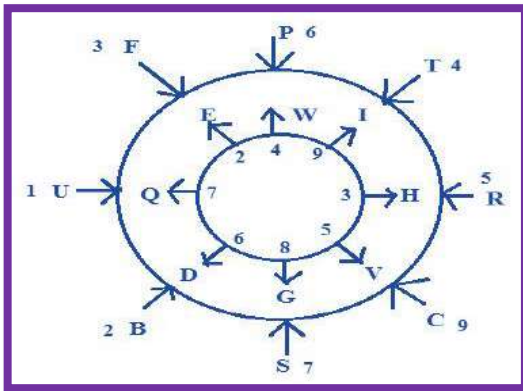
**Answer: C****Explanation-****Question 29**

Study the following information carefully to answer the given questions.

Ten persons from ten different countries viz. Mumbai, Chennai, Bengaluru, Kolkata, Pune, Hyderabad, Jaipur, Ahmedabad, Surat and Kochi are sitting in two parallel rows containing five people each, in such a way that there is an equal distance between adjacent persons. In row 1- A, B, C, D and E are seated and some of them are facing South and some of them are facing North. In row 2 - P, Q, R, S and T are seated and some of them are facing South and some of them are facing North. Therefore in the given seating arrangement, each member seated in a row either faces another member of the other row or seated behind each other. (All the information given above does not necessarily represent the order of seating in the final arrangement.). Each person stays in ten different floors numbered 1 to 12. (From Ground floor to Top floor)

There is only one floor between the person from Mumbai and the person from Pune. S is not from Bengaluru. D is neither from Pune nor from Hyderabad. P sits immediate right of the person from Surat. R sits one of the extreme ends of the line and from Surat. C sits third to the right of the person from Chennai. P does not face A and faces south direction. The person from Mumbai sits exactly between the persons from Kochi and Pune. The person from Hyderabad faces the person from Kochi. The person from Surat stays on the odd numbered floor. T faces North Direction and sits immediate left of Q. Only one person sit between the persons from Bengaluru and Kolkatta. The person from Kolkatta sits to the immediate right of Q, who seated exactly in the middle of the row. P faces one of the immediate neighbors of the person from Chennai. D faces one of the immediate neighbors of the person from Bengaluru. The person from Kochi stays on the top floor. Only One person sits between the person from Surat and Q. C sits to



the immediate right of the person who faces S. The person from Hyderabad stays on the 4<sup>th</sup> floor. Only two people sit between C and E. S is neither from Mumbai nor from Ahmedabad. The person from Pune sits second to the right of the one who faces North Direction. One of the immediate neighbors of the person from Pune behind the person from Bengaluru. A faces the opposite direction to the person from Jaipur. The persons from Bengaluru, Jaipur and Kolkata stay on the consecutive floors. The floor number of the person from Chennai is the double of the floor number of the person from Surat. The floor number of the B is the square of the floor number of P. Neither E nor A stays on floor numbered 6.

**29.1 Who amongst the following faces the person from Hyderabad?**

- (a) The person from Mumbai (b) D  
(c) The person from Pune (d) The person from Surat

**Answer: B**

**29.2 T stays on which of the following floors?**

- (a) 1 (b) 2  
(c) 4 (d) 6

**Answer: A**

**29.3 Which of the following is true regarding C?**

- (a) C faces south direction (b) None of the given options is true  
(c) C is from Bangladesh (d) The person from India faces C

**Answer: A**

**29.4 R is related to Kolkata in the same way as C is related to Pune based on the given arrangement, To who amongst the following is T related to the following same pattern?**

- (a) Mumbai (b) Sri Nagar  
(c) Bengaluru (d) Hyderabad

**Answer: D**

**29.5 Who amongst the following sit at extreme ends of the row?**

- (a) The person stays on 8<sup>th</sup> floor and R (b) The persons from Ahmedabad and A  
(c) D and the person stays on 10<sup>th</sup> floor (d) The persons from Hyderabad and Bengaluru

**Answer: C**

**Explanation-**

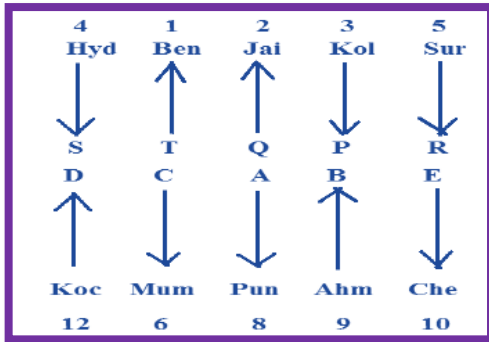

### Question 30

Study the following information carefully to answer the given questions.

Ten friends are sitting in two parallel rows of six seats each. One seat is vacant in each row. M, N, O, P and Q are sitting in row-1 facing south. D, E, F, G and H are facing North. Each likes a different Chocolate i.e. 5star, Dairy Milk, Munch, Kitkat, Perk, Snickers, Bourneville, Gems, Eclairs and Galaxy. Each person has different number of their favourite chocolates – 2, 3, 4, 6, 7, 8, 9, 11, 15 and 16. The difference between the chocolates hold by N and O is 3. G sits third to the right of F and likes Kitkat. Only two people sit between E and the vacant seat. E does not like Perk or Munch Chocolate. Q is not an immediate neighbour of O. N likes Galaxy. The persons who sit at the extreme end of the line have chocolates in consecutive order. Neither E nor H has 8 chocolate. One of the neighbors of vacant seat in both rows have chocolates in odd number. The one who likes Munch Chocolate faces the one who likes Gems. The one who likes Munch sits opposite to the one who sits third right of the person who sits opposite to G. O is not an immediate neighbour of P. H, who likes neither Perk nor Snickers, does not face the vacant seat. Neither G nor F sits at any of the extreme ends of the row. P faces F. Vacant seats are not opposite to each other. Two seats are there between O and N, who sits third right of the one who likes Bourneville. The one who likes Eclairs Chocolate faces the one who likes Kitkat. The persons who like the 5star and Gems are adjacent to each other. Vacant seat of row – 1 is not an immediate neighbour of P. E sits at one of the extreme ends of the row. F does not like 5star and Gems. Vacant seat of row-1 does not face G who doesn't sit at any of the extreme ends of the row. The person who likes 5star has 3 chocolates. The total number of chocolates hold by Q is the half of the total number of chocolates hold by H. The total numbers of chocolates hold by M, F and G is the Square of the total number of chocolates hold by P, Q and M respectively. Neither P nor G has 4 chocolate.

30.1 In the given arrangement, if two people come and sit to the immediate left of E, how many people will sit between D and E?

- (a) Two  
(b) Three  
(c) Four  
(d) More than four

**Answer: B**

**30.2 Who amongst the following sits third to the right of F?**

- (a) The one who likes Kitkat (b) E  
(c) Other than those given as options (d) D

**Answer: A**

**30.3 Which of the following faces the vacant seat of Row - 1?**

- (a) The one who likes Kitkat (b) E  
(c) Other than those given as options (d) The one who has 15 chocolate

**Answer: D**

**30.4 Four of the following five are alike in a certain way based upon their seating arrangement and so form a group. Which of the following does not belong to the group?**

- (a) QE (b) ND  
(c) HO (d) FP

**Answer: D**

**30.5 Who amongst the following has 11 chocolates?**

- (a) Q (b) N  
(c) D (d) E

**Answer: B**

**Explanation-**

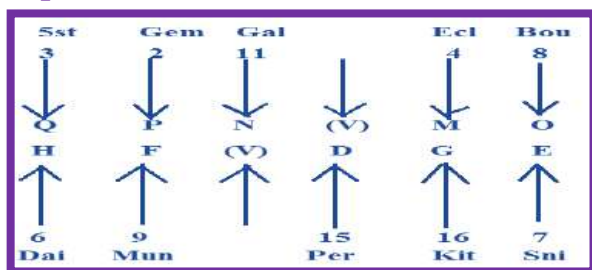

**Question 31**

Study the following information carefully to answer the given questions. Eight friends C, D, E, F, L, M, N and O are seated in a straight line, but not necessarily in the same order. Some of them are facing north while some face South. Only three people sit to the right of M. E sits second to the left of M. F sits third to the right of O. O is not an immediate neighbour of M. O does not sit at any of the extreme ends of the line. Both the immediate neighbours of O face south.

**D sits second to the right of N. As many people sit between M and D as between M and L. Immediate neighbours of F face opposite directions(i.e., If one person faces north then the other person faces south and vice-versa). C faces south. L and F face direction opposite to C. (i.e If C faces north then both L and F face south and vice-versa)**

**31.1 Which of the following is true, based on the given arrangement?**

- (a) D faces North (b) Only three people face South  
(c) L sits at one of the extreme ends of the line (d) O and E face the same directions

**Answer: D**

**31.2 How many people sit to the left of O?**

- (a) Two (b) Three  
(c) One (d) More than four

**Answer: C**

**31.3 Who amongst the following faces South?**

- (a) E (b) M  
(c) F (d) L

**Answer: B**

**31.4 Who amongst the following sits second to the left of L?**

- (a) O (b) F  
(c) D (d) No one as less than two people sit to the left of L

**Answer: B**

**31.5 Who amongst the following represent the persons sitting at extreme ends of the line?**

- (a) D, N (b) C, D  
(c) L, N (d) D, L

**Answer: B**

**Explanation-**

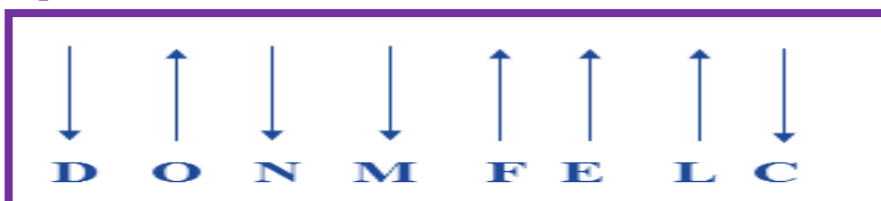

### **Question 32**

**Study the following information carefully to answer the given questions. Eight people B, C, D, E, F, G, H and I are sitting in a straight line with equal**

distances between each other, but not necessarily in the same order. Some of them are facing north and some of them are facing south.

E sits immediate right of the person who sits at one of the extreme ends of the line. Only three people sit between E and G. B sits exactly between D and H. C sits third to the right of H. F is an immediate neighbour of G and faces south. G sits second to the right of C. D sits third to the left of G. B and E face the same direction as C (i.e if C faces north then B and E also face North and Vice-Versa).

Immediate neighbours of G face opposite directions (i.e. if one neighbour faces North then the other neighbour faces south and Vice-Versa)

Person who sit at the extreme ends of the line face opposite directions (i.e. if one neighbour faces North then the other neighbour faces south and Vice-Versa) D and H face the same direction as I (i.e if I faces north then D and H also face North and Vice-Versa).

**32.1 In the given arrangement, how many people will sit between D and G?**

- |          |                    |
|----------|--------------------|
| (a) Two  | (b) Three          |
| (c) Four | (d) More than four |

**Answer: A**

**32.2 Who amongst the following sits third to the right of B?**

- |                                       |       |
|---------------------------------------|-------|
| (a) E                                 | (b) I |
| (c) Other than those given as options | (d) F |

**Answer: B**

**32.3 How many people face South as per the given arrangement?**

- |          |                    |
|----------|--------------------|
| (a) Two  | (b) Three          |
| (c) Four | (d) More than four |

**Answer: C**

**32.4 Four of the following five are alike in a certain way based upon their seating arrangement and so form a group. Which of the following does not belong to the group?**

- |        |        |
|--------|--------|
| (a) IH | (b) EG |
| (c) DF | (d) EB |

**Answer: D**

**32.5 Who amongst the following sits at the extreme right end of the row?**

- |       |       |
|-------|-------|
| (a) G | (b) C |
| (c) I | (d) H |

**Answer: B**

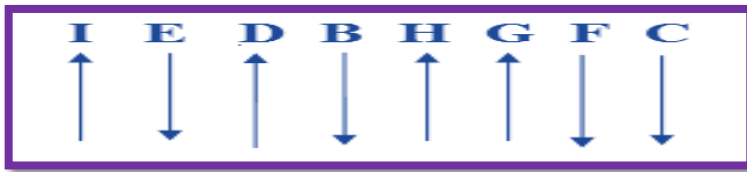
**Explanation-****Question 33**

Study the following information carefully to answer the given questions  
A group of eight friends – A, C, F, S, X, M, I and W – are sitting in a straight line facing north. Each of them has different company cars– Datsun, Renault, Hyundai, Tata, Maruti, Toyota, BMW and Volkswagen. Each of them likes different colours – Pink, Yellow, Red, Black, Blue, Orange, White and Green, but not necessarily in the same order. C, who has a Maruti car, sits third to the left of F. Neither C nor F sits at the extreme ends of the line. A, who likes Pink colour, has Hyundai car. A is not an immediate neighbour of either C or F. S is two places away from M and likes Orange colour. M, who has BMW car, likes Red colour. I, who has Datsun car, sits at an extreme end of the line and likes White colour. X, who has Tata car likes Green colour and sits on the immediate left of C. C does not like either Blue or Yellow colour. One who has Volkswagen sits on the immediate left of who has Datsun car. F, who has Renault car, does not like Yellow colour.

**33.1 The person who likes yellow has which company car?**

- |            |          |
|------------|----------|
| (a) Datsun | (b) BMW  |
| (c) Toyota | (d) Tata |

**Answer: C**

**33.2 What is the position of F with respect to X ?**

- |                         |                        |
|-------------------------|------------------------|
| (a) Fourth to the right | (b) Second to the left |
| (c) Immediate right     | (d) Third to the left  |

**Answer: A**

**33.3 If A is related to black, W is related to Blue then M is related with which color?**

- |           |            |
|-----------|------------|
| (a) Green | (b) Orange |
| (c) White | (d) Pink   |

**Answer: B**

**33.4 Four of the following five are alike in a certain way based on their position, which one does not belong to that group?**

- |         |         |
|---------|---------|
| (a) WFI | (b) ACM |
| (c) SMC | (d) XCW |

**Answer: D**

**33.5 Which of the following is correct according to the given information?**

- (a) Two persons sits between W and who likes pink colour  
 (b) X and I are sits at the extreme end of the line  
 (c) X is sit between who has Maruti and Hyundai cars  
 (d) Both 1 and 3

**Answer: D**

**Explanation:**

Pink	Green	Black	Yellow	Red	Blue	Orange	White
A	X	C	W	M	F	S	I
Hyundai	Tata	Maruti	Toyota	BMW	Renault	Volkswagen	Datsun

### Question 34

Study the following information carefully to answer the given questions

Ten Stationery items Pencil, Books, Notes, Pens, Sharpners, Chalk, Stickers, Gum, Scale, Covers are placed in 10 boxes numbered 1, 2, 3, 4, 5, 6, 7, 8, 9 and 10 are placed adjacent to one another in two different rows of 5 boxes each.

Boxes with odd numbers are situated opposite to the boxes with even numbers and no two even number boxes with even number and no two boxes with odd numbers are adjacent to each other. No two boxes have consecutive numbers.

Box no 8 is occupied by books and it is to the extreme left of one end of the row.

Box 4 and 6 are not in the row of box no 8 and any of the boxes numbered 4, 6, and 3 are not in the middle of the row.

Gums are placed in Box no 5.and its box is not situated in the row where box no 6 is situated.

Notes are placed in an odd numbered box and placed in a row where Books are situated but both are not adjacent to each other.

Sharpner's and Chalk's box are adjacent to box no 6 and Chalk's box is not adjacent to box no 4.

Pencil's & Cover's box are placed in the same row. Pen's box is even numbered but not 10 and diagonally opposite to box no 1 which contains stickers

Box no 6 is second from the one of the end of the row. Stickers's box is neither opposite to Sharpners's box nor adjacent to it.

**34.1 The pack of notes are placed in which number box ?**

- (a) 7  
 (b) 9  
 (c) 8  
 (d) 3

**Answer: A****34.2 Covers are kept in which number box?**

- (a) 4 (b) 6  
(c) 3.2 (d) Can't be determined

**Answer: D****34.3 The number 9 box is placed opposite to which box and contains which stationery?**

- (a) 5, Chalk (b) 6, Covers  
(c) 8, Pens (d) 10, scale

**Answer: D****34.4 If pencil is placed in the box numbered 4 then which box is placed opposite to the box which contains pencils ?**

- (a) Pencils (b) Covers  
(c) Stickers (d) Gum

**Answer: D****34.5 If the box 1 is related to Sharpners, box 10 is related to Pens then Box 8 is related with?**

- (a) Scale (b) Books  
(c) Chalk (d) Notes

**Answer: A****Explanation:**

1[Stickers]	4[Pencil/Covers]	9[Sharpners]	6[Pencil/Covers]	3[Chalk]
8[Books]	5[Gum]	10[Scale]	7[Notes]	2[Pens]

**Question 35**

Study the following information carefully to answer the given questions P, Q, R, S, T, U, V and W are eight members of 3 different families who belongs to 3 different cities such as Mumbai, Mysore and Thanae. They go for shopping in 3 different cars A, B and C. Out of 8 members 4 are female. Each member of a family is travelling in a different car. Each car carries at least one male, one female and each family has at least 2 members.

P belongs to Thana and he is travelling in car C. S is wife of T and they are travelling in Car A and B. W is son of Q who is wife of V and they belong to Mysore. R is daughter of U who is wife of P. R is travelling in car B. V is not travelling with U.



**35.1 Which of the following group belongs to Mumbai?**

- (a) T,V (b) S,T  
(c) U,W (d) P,S

**Answer: B**

**35.2 Which of the following group travelling in Car B ?**

- (a) S,V,P (b) R,V,W  
(c) P,Q,R (d) R,T,V

**Answer: D**

**35.3 V belongs to which city?**

- (a) Mysore (b) Mumbai  
(c) Thanae (d) Either Mumbai or Mysore

**Answer: A**

**35.4 Which of the following is true?**

- (a) P travelling in Car B (b) R travelling in Car A  
(c) V travelling in Car B (d) T travelling in Car C

**Answer: C**

**35.5 Which of the following combination is not true?**

- (a) T -Mumbai - B (b) W -Mysore - A  
(c) P - Thanae - C (d) W - Mumbai - B

**Answer: D**

**Explanation:**

Person	City	Car
P	Thana	C
Q	Mysore	C
R	Thana	B
S	Mumbai	A
T	Mumbai	B
U	Thana	A
V	Mysore	B
W	Mysore	A

### **Question 36**

**Study the following information carefully to answer the given questions**  
**10 people are sitting in 2 parallel rows containing 5 people each in such a way that there is an equal distance between adjacent persons. In row 1 - A, B, C, D and E are seated facing north and in row 2 - U, V, W, X and Y are seated and facing south. Each person's like different dishes- Dosa, Poori, Chapathi, Idly, Samosa, Pizza, Pongal, Parotta, Briyani and Pasta.**

E is sitting exactly in the centre of the row and faces the one who likes Idly. Only 1 person sits between E and the one who likes Samosa. X faces the immediate neighbour of the one who likes Samosa. Only 1 person sits between U and the one who likes Idly. U is not an immediate neighbour of X. U faces one of the immediate neighbours of C. D is neither an immediate neighbour of C nor faces X.

V is not an immediate neighbour of X and faces the one who likes Poori. D does not face W. D faces one of the immediate neighbours of the one who likes Pizza. Only 1 person sits between the one who likes Pizza and the one who likes Dosa. The one who likes Briyani and the one who likes Parotta face each other. Only 2 people sit between the one who likes Parotta and the one who likes Pongal. A does not like Pongal. The one who likes Pasta sits fourth to the right of the one who likes Briyani.

**36.1 Which of the following dish does X likes?**

- (a) Pizza (b) Pasta  
(c) Poori (d) Pongal

**Answer: A**

**36.2 Which of the following pairs represents the people sitting at the extreme ends of the row 1?**

- (a) BE (b) AD  
(c) AC (d) CB

**Answer: B**

**36.3 Who among the following likes Briyani?**

- (a) X (b) Y  
(c) V (d) U

**Answer: D**

**36.4 Who among the following immediate neighbors of C ?**

- (a) BA (b) CE  
(c) AE (d) DE

**Answer: D**

**36.5 Which of the following is correct?**

- (a) A faces V (b) C faces X  
(c) E faces W (d) D faces U

**Answer: C**

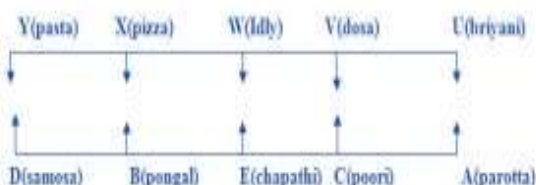

E faces W

# PAST EXAMINATION QUESTIONS:

## MAY 2018

### Question 1

Five boys A, B, C, D and E are sitting in a row A is to the right of B, and E to the left of B but to the right of A is to the left of D. Who is second from the left end?

- (a) D (b) A  
(c) E (d) B

**Answer: C**

**Explanation:**

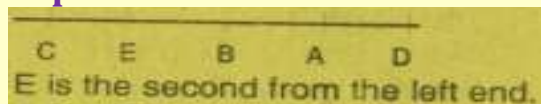

### Question 2

Five senior citizens are living in a multistoried building Mr. Muan lives a flat above Mr. Ashokan, Mr. Lokesh in a flat below Mr. Gaurav, Mr. Ashokan lives in a flat below Mr. Gaurav and Mr. Rakesh lives in a flat below Mr. Lokesh. Who lives in the top most flat?

- (a) Mr. Lokesh (b) Mr. Gaurav  
(c) Mr. Manu (d) Mr. Rakesh

**Answer: C**

**Explanation:**

Mr. Manu lives in the top most flat.

### Question 3

Six children A, B, C, D, E and Fare standing in a row. B is between F and D. E is between A and C. A does not stand next to F or D. C does not stand next to D. F is between which of the following pairs of children?

- (a) B and E (b) B and C  
(c) B and D (d) B and A

**Answer: B**

**Explanation:**

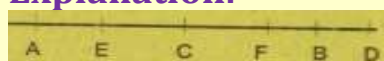

F is between B & C

### Question 4

Five children are sitting in a row. S is sitting next to P but not T. K is sitting

next to R, who is sitting on the extreme left and T is not sitting next to K. Who is/are adjacent to S.

- (a) K+P (b) R+P  
(c) Only P (d) P and T

**Answer: D**

**Explanation:**

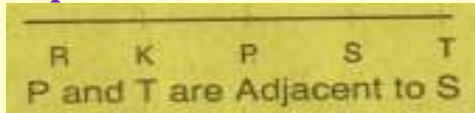

### Question 5

Five boys A, B, C, D and E are sitting in a row. A is to the right of B and E is to the left of B but to the right of C. A is to the left of D. Who is second from the left end?

- (a) D (b) A  
(c) E (d) B

**Answer: C**

**Explanation:**

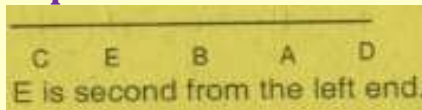

## NOV 2018

### Question 1

Eight persons A, B, C, D, E, F, G and H are sitting in a line. E sits second right to D. H sits fourth left to D. C and F are immediate neighbours, but C is not immediate neighbor of A. G is not neighbor of E. Only two persons sit between A and E. The persons on left end and right end respectively are

- (a) G and E (b) B and E  
(c) H and E (d) G and B

**Answer: A**

**Explanation:**

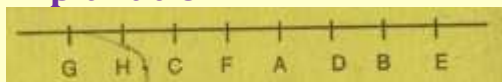

The Person on the left end = G

The Person On the right end = E

### Question 2

Six children A, B, C, D, E and F are sitting in a row. B is between F and D. E is between A and C. However, A does not sit next to F or D. C does not sit next to D. Then, F is sitting between;

- (a) B and C (b) E and C  
(c) B and D (d) None of the above

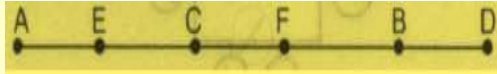
**Answer: A****Explanation:**

F is sitting b/w B and C

**Question 3**

Five students A, B, C, D and E are standing in a row. D is on the right of E, B is on the left of E but on the right of A. D is next to C on his left. The student in middle is

- (a) B (b) E  
(c) C (d) A

**Answer: B****Explanation:**

The student in middle is 'E'

**MAY 2019****Question 1**

Five boys A, B, C, D, E are sitting in a row A is to the right of B and E is to the left of B but to the right of C. A is to the left of D who is second from the left end?

- (a) D (b) A  
(c) E (d) B

**Answer: C****Explanation:**

C E B A D

**Question 2**

5 children are sitting in a row. S is sitting next to P but not T. K is sitting next to R. K is sitting on extreme end. T is not sitting next to K. Who are sitting adjacent to S.

- (a) K & P (b) R & P  
(c) Only P (d) P & T

**Answer: D****Explanation:**

P ST R K

**Question 3**

Four girls are seated for a photograph. Shikha is left of Reena. Manju is to the right of Reena. Rita is between Reena and Manju. Who is the second left in photograph?

- (a) Reena  
(c) Rita

- (b) Manju  
(d) Shikha

**Answer: C**

**Explanation:**

Shikha, Reena, Rita, Manju



2<sup>nd</sup> Left

#### **Question 4**

**Which of the following people are sitting to the right of S?**

- (a) OTPQ  
(c) UNVM

- (b) OTPR  
(d) UOTPR

**Answer: B**

**Explanation:**

The arrangement of the persons is Q W M V N U S O T P R OTPR are sitting to the right of S.

## **NOV 2019**

#### **Question 1**

**Six person are sitting in a circle facing the circler Parikh is between Bablu and Narender Ashok is between Chitra and Pankaj. Chitra is immediate left of Bablu. Who is immediate right of Bablu?**

- (a) Parikh  
(c) Narender

- (b) Pankaj  
(d) Chitra

**Answer: A**

**Explanation:**

According to question;

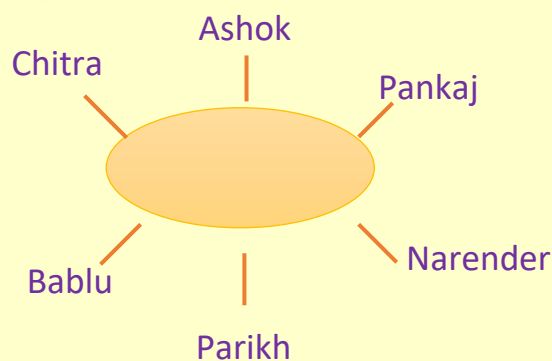

So Parikh is immediate right of Bablu.

#### **Question 2**

**C is between A and B. € is at the extreme right D is on the left of Who is at the middle?**

- (a) A

- (b) B

(c) D

(d) E

**Answer: B****Explanation:**

According to question,

A C B D E

So B is in the middle.

**Question 3**

5 person are standing in a line one of the 2 persons at the extreme ends is a professor and other a business man. An advocate is standing to the right of student. An author is to the left of the business man. The student is standing between the professor and advocate. Counting from left. The author is at which place?

(a) 2

(b) 3

(c) 4

(d) none

**Answer: C****Explanation:**

According to given ques;

Professor Student Advocate Author BusinessmanAuthor is 4<sup>th</sup> from the left.**IAN 2021****Question 1**

A, B, C and D are playing cards. A and B are partners. D faces towards north. If A faces west, then who faces south?

(a) C

(b) B

(c) D

(d) Data inadequate

**Answer: A****Explanation:**

As per the data D faces North A faces towards west So its partner B will face towards A and hence towards East So C who will face D will face towards south.

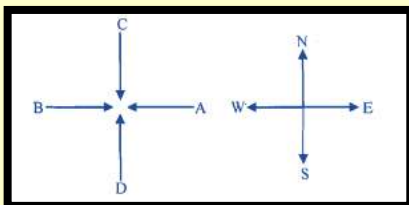
**Question 2**

A is seated between D and F at a round table. C is seated opposite to D. E is round adjust to D. who sis opposite to B?

(a) A

(b) D

(c) C

(d) F

**Answer: a**

**Explanation:**

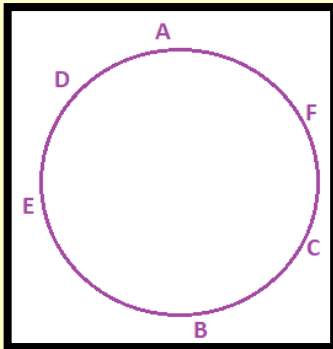

**WHO IS UPPER**

**Question 3**

For Indian A, B, C and D and four Chinese E, F, G and H are sitting in a circle around a table facing the each other in a conference. No two Indians or Chinese are sitting side by side, C who is sitting between G and F is being D, F is between D and A and facing G, H is to the right of B. who is sitting left of A?

- (a) E (b) F  
(c) G (d) H

**Answer: a**

**Explanation:**

**Question 4**

Five friends A, B, C, D and E are sitting on a bench. A is sitting next to B; C is setting next to D, D is not sitting with E; E is at the left end of bench. C is on second position from the right; A is on the right side of B and to the right side of E. A and C are sitting together. What is the position of B?

- (a) Second from right (b) Centre  
(c) Extreme left (d) Second from left

**Answer: d**

**Explanation:**

**JULY 2021**

**Question 1**

A, B, C, D and E are sitting on a bench. A is sitting next to B, C is on the left end of the bench. C is on the second position from the right. A is to the right of B and E. A I and C are sitting together. In which position A is sitting between?

- (a) C and D (b) D and E  
(c) B and C (d) B and E

**Answer: Options (c)**



Explanation:

**Between B and C**

. . . . .  
E B A C D

Therefore, A is sitting in between B and C.

### **Question 2**

**Five girls are sitting on a bench to be photographed. Seema is to the left of Rani and to the right of Bindu. Mary is to the right of Rani. Reeta is between Rani and Mary. Who is sitting immediate right to Reeta?**

- |           |          |
|-----------|----------|
| (a) Seema | (b) Rani |
| (c) Bindu | (d) Mary |

**Answer: Options (d)**

**Explanation**

We are given that five girls are sitting on a bench to be photographed.

Seema is to the left of Rani and to the right of Bindu.

So, sequence (Facing towards photographer): Rani, Seema , Bindu

So, Seema is to the left of Rani and to the right of Bindu.

Now we are given that Mary is to the right of rani

Sequence: Mary, Rani, Seema, Bindu

Now we are given that reeta is between rani and Mary

So, Sequence: Mary, Reeta, Rani, Seema, Bindu

Now we are asked who is sitting immediate right to reeta

**Ans:** Mary is sitting immediate right to Reeta.

### **Question 3**

**Six friends P, Q, R, S, T and U are sitting around the hexagonal table each at one corner and are facing the centre of the hexagonal. P is second to the left of U. Q is neighbour of R and S. T is second to the left of S. Which one is sitting opposite to S?**

- |       |       |
|-------|-------|
| (a) R | (b) P |
| (c) Q | (d) T |

**Answer: Options (b)**

**Explanation:**

S is sitting opposite to P

Step-by-step explanation:

Let mark corners

1 2 3 4 5 6 clock wise

P is second to the left of u

Assume P is at 1 then U would be at 3

Q is a neighbour of R and S

=> Q, must be at 5 & R & S would be at 2 & 4  
 Hence at remaining position 2 would be T  
 T is second to the left of S  
 => S will be at 4  
 P is at 1 so opposite is 4 - S  
 S is sitting opposite to P

#### **Question 4**

**A, B, C, D, E, F and G are sitting in a row facing North:**

- 1. F is to the immediate right of E**
- 2. E is 4<sup>th</sup> to the right to G**
- 3. C is the neighbour of B and D**
- 4. Person who is third to the left of D is at one of ends**

**Who are right of D?**

- |                  |                  |
|------------------|------------------|
| (a) E and F only | (b) G, b and C   |
| (c) E, F and A   | (d) G and B only |

**Answer: Options (c)**

## **DEC 2021**

#### **Question 1**

**Six children, named as P Q, R, S, T and U, are sitting in a row, Q is between U and S, T is between P and R, P does not sit next to either U or S. R does not sit next to S. So, U is sitting between the pairs of children.**

- |             |             |
|-------------|-------------|
| (a) Q and T | (b) Q and R |
| (c) Q and S | (d) Q and P |

**Answer: b**

**Explanation:**

P T R U Q S

#### **Question 2**

**Five persons A, B, C, D and E are sitting in a row. A sits left to C and C sits left to B. E sits right to B, D sits in between E and B. Who is sitting in the middle?**

- |       |       |
|-------|-------|
| (a) B | (b) C |
| (c) E | (d) D |

**Answer: a**

**Explanation:**

A C B D E

#### **Question 3**

**Four ladies A, B, C and D and four Gentlemen E, F, G and H are sitting in a circle around a table facing each other.**

- I. No two ladies or gentleman are sitting side by side.
- II. C, who is sitting between G and E, is facing D.
- III. F is between D and A facing G.
- IV. H is to the right of B.

**Who is immediate neighbour of B?**

- (a) G and H
- (b) E and F
- (c) E and G
- (d) A and B

**Answer: a**

**Explanation:**



**Question 4**

Persons M, N, O, P, Q, R, S, and T are sitting on a compound wall facing North. O sits fourth left of S; P sits second to the right of S; only two people sit between P and M; N and R are immediate neighbours of each other. N is not an immediate neighbour of M; T is not the neighbour of P. How many persons are seated between M and Q?

- (a) One
- (b) Two
- (c) Three
- (d) Four

**Answer: a**

**Explanation:**

T O N R M S Q P

**Question 5**

In a line, P is sitting 13<sup>th</sup> from left. Q is sitting 24<sup>th</sup> from the right and 3<sup>rd</sup> left from P. How many people are sitting in the line?

- (a) 34
- (b) 31
- (c) 32
- (d) 33

**Answer:**

**Explanation:**

Q is sitting 3<sup>rd</sup> left of P, and Q is the 24<sup>th</sup> position from the right.

..	10 <sup>th</sup>	11 <sup>th</sup>	12 <sup>th</sup>	13 <sup>th</sup>	14 <sup>th</sup>	15 <sup>th</sup>	..
	Q						

Since Q is 24<sup>th</sup> and 3<sup>rd</sup> left of P, it means Q is on the 10<sup>th</sup> place from the left. This means that counting the position of Q, there are 24 positions to the right. Therefore, counting from 11<sup>th</sup> position, there are

23 positions to the right.

Therefore, total number of places =  $10 + 23 = 33$ .

## JUNE 2022

### Question 1

If six person are sitting in a hexagonal table are P, Q, R, S, T, U each facing the centre. P is seated to opposite to Q who is b/w R & S. P is b/w T and U. T is the left of S. Which of them facing R?

- (a) P (b) Q  
(c) U (d) T

**Answer: Options (d)**

**Explanation:**

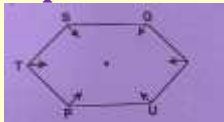

T is the facing of R

### Question 2

Five boys A, B, C, D, E, are sitting in a row. A is the right of B and E is to the left of B, but to the right of C. A is to left of D. Who is second from the left end?

- (a) D (b) A  
(c) E (d) B

**Answer: Options (2)**

**Explanation:**



'E is the second from the left end'