

## CHAPTER - 12

### BLOOD RELATIONS

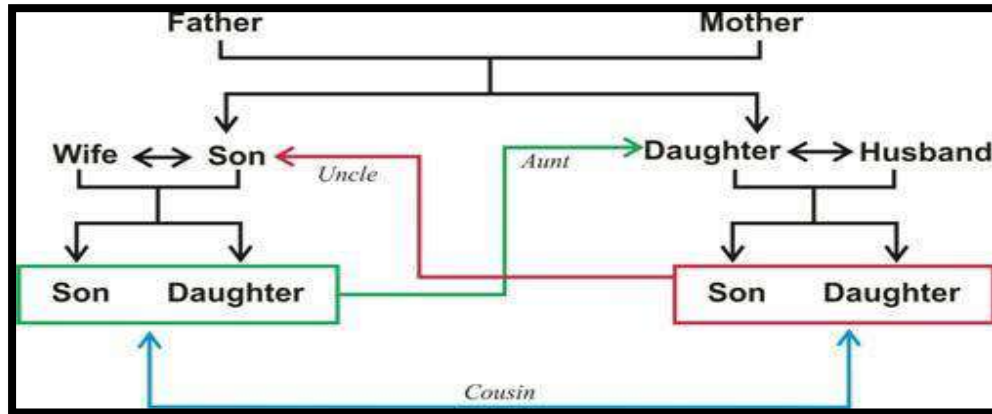

A person who is related to another by birth rather than by marriage. Family or Blood Relationship means persons connected by relations like - father-mother, son-daughter, brother-sister, grandfather-grandmother, uncle-aunt, nephew-niece, brother-in-law, sister-in-law etc. The list can go on and on adding members from father's side and mother's side etc.

S.no	Relationship	Commonly Used Terms
1	Father's son (or) mother's son	<b>Brother</b>
2	Father's daughter (or) mother's daughter	<b>Sister</b>
3	Mother's brother	<b>Uncle</b> (Paternal Uncle)
4	Father's brother	<b>Uncle</b> (Maternal Uncle)
5	Mother's sister	<b>Aunt</b> (Paternal Aunt)
6	Father's sister	<b>Aunt</b> (Maternal Aunt)
7	Son's wife	<b>Daughter-in-law</b>
8	Daughter's husband	<b>Son-in-law</b>
9	Sister's husband	<b>Brother-in-law</b>
10	Husband's brother (or) wife's brother	<b>Brother-in-law</b>
11	Brother's wife	<b>Sister-in-law</b>
12	Husband's sister (or) wife's sister	<b>Sister-in-law</b>
13	Husband's father (or) wife's father	<b>Father-in-law</b>
14	Husband's mother (or) wife's mother	<b>Mother-in-law</b>
15	Brother's son (or) sister's son	<b>Nephew</b>
16	Brother's daughter (or) Sister's	<b>Niece</b>
17	Uncle's daughter (or) Aunt's daughter	<b>Cousin</b>
18	Uncle's Grand son (or) Aunt's Grand son	<b>Nephew</b>
19	Father's father (or) mother's father	<b>Grandfather</b>
20	Father's mother (or) mother's mother	<b>Grandmother</b>
21	Father of Grandfather or Father of grandmother	<b>Great Grandmother</b>
22	Father of Grandfather (or) father of grandmother	<b>Great Grandfather</b>



**Question 1**

**Pointing to a photograph of a boy Shinzo said, "He is the son of the only son of my mother." How is Shinzo related to that boy?**

- (a) Father (b) Brother  
(c) Uncle (d) Cousin

**Answer: a**

**Explanation:**

The boy in the photograph is the only son of the son of Shinzo's mother i.e., the son of Shinzo. Hence, Shinzo is the father of boy.

**Question 2**

**If A + B means A is the mother of B; A - B means A is the brother B; A % B means A is the father of B and A x B means A is the sister of B, which of the following shows that P is the maternal uncle of Q?**

- (a)  $Q - N + M \times P$  (b)  $P + S \times N - Q$   
(c)  $P - M + N \times Q$  (d)  $Q - S \% P$

**Answer: C**

**Explanation:**

$P - M \rightarrow P$  is the brother of  $M$

$M + N \rightarrow M$  is the mother of  $N$

$N \times Q \rightarrow N$  is the sister of  $Q$

Therefore,  $P$  is the maternal uncle of  $Q$

**Question 3**

**If A is the brother of B; B is the sister of C; and C is the father of D, how D is related to A?**

- (a) Brother (b) Sister  
(c) Nephew (d) Cannot be determined

**Answer: D**

**Explanation:**

If  $D$  is Male, the answer is Nephew.

If  $D$  is Female, the answer is Niece.

As the sex of  $D$  is not known, hence, the relation between  $D$  and  $A$  cannot be determined.

**Note:** Niece - A daughter of one's brother or sister, or of one's brother-in-law or sister-in-law. Nephew - A son of one's brother or sister, or of one's brother-in-law or sister-in-law

**Question 4**

**If A + B means A is the brother of B; A - B means A is the sister of B and A x B means A is the father of B. Which of the following means that C is the son of M?**

- (a)  $M - N \times C + F$
- (b)  $F - C + N \times M$
- (c)  $N + M - F \times C$
- (d)  $M \times N - C + F$

**Answer: D**

**Explanation:**

$M \times N \rightarrow$  M is the father of N  
 $N - C \rightarrow$  N is the sister of C  
and  $C + F \rightarrow$  C is the brother of F.  
Hence, M is the father of C or C is the son of M

**Question 5**

**Introducing a boy, a girl said, "He is the son of the daughter of the father of my uncle." How is the boy related to the girl?**

- (a) Brother
- (b) Nephew
- (c) Uncle
- (d) Son-in-law

**Answer: A**

**Explanation:**

The father of the boy's uncle  $\rightarrow$  the grandfather of the boy and daughter of the grandfather  $\rightarrow$  sister of father

**Question 6**

**Pointing to a photograph Lata says, "He is the son of the only son of my grandfather." How is the man in the photograph related to Lata?**

- (a) Brother
- (b) Uncle
- (c) Cousin
- (d) Data is inadequate

**Answer: A**

**Explanation:**

The man in the photograph is the son of the only son of Lata's grandfather i.e., the man is the son of Lata's father. Hence, the man is the brother of Lata.

**Question 7**

**If A + B means A is the brother of B; A x B means A is the son of B; and A % B means B is the daughter of A then which of the following means M is the maternal uncle of N?**

- (a)  $M + O \times N$
- (b)  $M \% O \times N + P$
- (c)  $M + O \% N$
- (d) None of these

**Answer:D**

**Explanation:**

Because the sex of O is not known

**Question 8**

**If D is the brother of B, how B is related to C? To answer this question which of the statements is/are necessary? The son of D is the grandson of C. B is the sister of D.**

- |                   |                               |               |
|-------------------|-------------------------------|---------------|
| (a) Only 1        | (b) Only 2                    | Only 1        |
| (c) Either 1 or 2 | (d) 1 and 2 both are required | Either 1 or 2 |

**Answer:D**

**Explanation:**

Given: D is the brother of B.

From statement 1, we can detect that D is son of C (son of D is the grandson of C).

From statement 2, we can detect that B is 'Female' (sister of D).

Therefore, B is daughter of C.

**Question 9**

**If A + B means A is the father of B; A - B means A is the brother B; A % B means A is the wife of B and A x B means A is the mother of B, which of the following shows that M is the maternal grandmother of T?**

- |                           |                                |               |
|---------------------------|--------------------------------|---------------|
| (a) $M \times N \% S + T$ | (b) $M \times N - S \% T$      | Only 1        |
| (c) $M \times S - N \% T$ | (d) $M \times N \times S \% T$ | Either 1 or 2 |

**Answer: A**

**Explanation:**

$M \times N \rightarrow$  M is the mother of N

$N \% S \rightarrow$  N is the wife of S

and  $S \rightarrow T$  is the father of T.

Hence, M is the maternal grandmother of T

**Question 10**

**Pointing to a photograph. Bajpai said, "He is the son of the only daughter of the father of my brother." How Bajpai is related to the man in the photograph?**

- |            |                    |               |
|------------|--------------------|---------------|
| (a) Nephew | (b) Brother        | Only 1        |
| (c) Father | (d) Maternal Uncle | Either 1 or 2 |

**Answer: D**

**Explanation:**

The man in the photo is the son of the sister of Bajpai. Hence, Bajpai is the maternal uncle of the man in the photograph

**Question 11**

**Deepak said to Nitin, "That boy playing with the football is the younger of the two brothers of the daughter of my father's wife." How is the boy playing football related to Deepak?**

- |            |                    |               |
|------------|--------------------|---------------|
| (a) Son    | (b) Brother        | Only 1        |
| (c) Cousin | (d) Brother-in-law | Either 1 or 2 |

**Answer: B**

**Explanation:**

Father's wife → mother. Hence, the daughter of the mother means sister and sister's younger brother means brother. Therefore, the boy is the brother of Deepak.

**Question 12**

**Pointing a photograph X said to his friend Y, "She is the only daughter of the father of my mother." How X is related to the person of photograph?**

- |              |                       |               |
|--------------|-----------------------|---------------|
| (a) Daughter | (b) Son               | Only 1        |
| (c) Nephew   | (d) Cannot be decided | Either 1 or 2 |

**Answer: B**

**Explanation:**

'The only daughter of the father of X's mother' means mother of X.

Hence X is the son of the lady in the photograph.

Note: Still have doubt like "How X is a male?"

**Question 13**

**Veena who is the sister-in-law of Ashok, is the daughter-in-law of Kalyani. Dheeraj is the father of Sudeep who is the only brother of Ashok. How Kalyani is related to Ashok?**

- |                   |                   |               |
|-------------------|-------------------|---------------|
| (a) Mother-in-law | (b) Aunt          | Only 1        |
| (c) Wife          | (d) None of these | Either 1 or 2 |

**Answer: D**

**Explanation:**

Ashok is the only brother of Sudeep and Veena is the sister-in-law of Ashok. Hence Veena is the wife of Sudeep. Kalyani is the mother-in-law of Veena.

Kalyani is the mother of Ashok.

**Question 14**

If A + B means A is the sister of B; A x B means A is the wife of B, A % B means A is the father of B and A - B means A is the brother of B. Which of the following means T is the daughter of P?

(a) P x Q % R + S - T

(b) P x Q % R - T + S

Only 1

(c) P x Q % R + T - S

(d) P x Q % R + S + T

Either 1 or 2

**Answer: B**

**Explanation:**

P x Q → P is the wife of Q

Q % R → Q is the father of R

R - T → R is the brother of T

T + S → T is the sister of S.

Therefore, T is the daughter of P.

**Question 15**

Pointing to a woman, Abhijit said, "Her granddaughter is the only daughter of my brother." How is the woman related to Abhijit?

(a) Sister

(b) Grandmother

Only 1

(c) Mother-in-law

(d) Mother

Either 1 or 2

**Answer: D**

**Explanation:**

Daughter of Abhijit's brother → niece of Abhijit. Thus the granddaughter of the woman is Abhijit's niece.

Hence, the woman is the mother of Abhijit.

**Question 16**

Amit said - "This girl is the wife of the grandson of my mother". How is Amit related to the girl?

(a) Brother

(b) Grandfather

Only 1

(c) Husband

(d) Father-in-law

Either 1 or 2

**Answer: D**

**Explanation:**

The girl is the wife of grandson of Amit's mother i.e., the girl is the wife of

son of Amit. Hence, Amit is the father-in-law of the girl.

**Question 17**

**A and B are children of D. Who is the father of A? To answer this question which of the statements (1) and (2) is necessary?**

- 1. C is the brother of A and the son of E.**
- 2. F is the mother B.**

- |                       |                      |               |
|-----------------------|----------------------|---------------|
| (a) Only (1)          | (c) Only (2)         | Only 1        |
| (b) Either (1) or (2) | (d) (1) and (2) both | Either 1 or 2 |

**Answer: B**

**Explanation:**

A and B are children of D.

From (1), C is the brother B and son of E.

Since, the sex of D and E are not known. Hence (1) is not sufficient to answer the question.

From (2). F is the mother of B. Hence, F is also the mother of A. Hence D is the father of A.

Thus, (2) is sufficient to answer the question.

**Question 18**

**Pointing towards a man, a woman said, "His mother is the only daughter of my mother." How is the woman related to the man?**

- |            |                 |               |
|------------|-----------------|---------------|
| (a) Mother | (b) Grandmother | Only 1        |
| (c) Sister | (d) Daughter    | Either 1 or 2 |

**Answer: A**

**Explanation:**

Only daughter of my mother → myself.

Hence, the woman is the mother of the man.

**Question 19**

**If P \$ Q means P is the brother of Q; P # Q means P is the mother of Q; P \* Q means P is the daughter of Q in A # B \$ C \* D, who is the father?**

- |       |                        |               |
|-------|------------------------|---------------|
| (a) D | (b) B                  | Only 1        |
| (c) C | (d) Data is inadequate | Either 1 or 2 |

**Answer: A**

**Explanation:**

A is the mother of B, B is the brother of C and C is the daughter of D. Hence, D is the father.

A (Parents) D



B - is - Brother - of - C

### Question 20

**Introducing Sonia, Aamir says, "She is the wife of only nephew of only brother of my mother." How Sonia is related to Aamir?**

- (a) Wife (b) Sister Only 1  
(c) Sister-in-law (d) Data is inadequate Either 1 or 2

**Answer:A**

**Explanation:**

Brother of mother means maternal uncle. Hence only nephew of Aamir's maternal uncle means Aamir himself. Therefore, Sonia is the wife of Aamir

### Question 21

**If A + B means A is the brother of B; A % B means A is the father of B and A x B means A is the sister of B. Which of the following means M is the uncle of P?**

- (a) M % N x P (b) N x P % M Only 1  
(c) M + S % R % P (d) M + K % T x P Either 1 or 2

**Answer:D**

**Explanation:**

M + K → M is the brother of K

K % T → K is the father of T

T x P → T is the sister of P

Therefore, K is the father of P and M is the uncle of P.

### Question 22

**Pointing to Varman, Madhav said, "I am the only son of one of the sons of his father." How is Varman related to Madhav?**

- (a) Nephew (b) Uncle Only 1  
(c) Father or Uncle (d) Father Either 1 or 2



**Answer: C**

**Explanation:**

Madhav is the only son of one of the sons of Varman's father → Either Varman is the father or uncle of Madhav.

**Question 23**

**Introducing a woman, Shashank said, "She is the mother of the only daughter of my son." How that woman is related to Shashank?**

(a) Daughter

(b) Sister-in-law

Only 1

(c) Wife

(d) Daughter-in-law

Either 1 or

**Answer: D**

**Explanation:**

The woman is the mother of Shashank's granddaughter. Hence, the woman is the daughter-in-law of Shashank.

**Question 24**

**If A + B means B is the brother of A; A x B means B is the husband of A; A - B means A is the mother of B and A % B means A is the father of B, which of the following relations shows that Q is the grandmother of T?**

(a)  $Q - P + R \% T$

(b)  $P \times Q \% R - T$

Only 1

(c)  $P \times Q \% R + T$

(d)  $P + Q \% R - T$

Either 1 or

**Answer: A**

**Explanation:**

$Q - P \rightarrow$  Q is the mother of P

$P + R \rightarrow$  R is the brother of P

Hence,  $\rightarrow q$  is the mother of R

$R \% T \rightarrow$  R is the father of T.

Hence, Q is the grandmother of T

**Question 25**

**A3P means A is the mother of P**

**A4P means A is the brother of P**

**A9P means A is the husband of P**

**A5P means A is the daughter of P**

**Which of the following means that K is the mother-in-law of M?**

- (a) M9N3K4J
- (c) K5J9M3N

- (b) M9N5K3J
- (d) K3J9N4M

Only 1  
Either 1 or

**Answer: B**

**Explanation:**

M9N → M is the husband of N

N5K → N is the daughter of K

Hence, → M is the son-in-law of K

K3J → K is the mother of J

Hence, → K is a lady

Hence, → K is the mother-in-law of M

### Question 26

**Introducing Neeta, Anil said, 'She is wife of my mother's only son. How is Neeta related to Anil?'**

- (a) Mother
- (b) Wife
- (c) Sister
- (d) Daughter-in-law

**Answer: B**

**Explanation:**

Neeta is the wife of Anil's mother's only son, who is Anil himself. Hence, answer is Neeta is Anil's wife. i.e. **(B) Wife.**

### Question 27

**'Ram' is the father of 'Kusha' but 'Kusha' is not his son. 'Mala' is the daughter of 'Kusha'.' Shalaka' is the spouse of 'Ram'. 'Gopal' is the brother of 'Kusha'. 'Hari' is the son of 'Gopal'. 'Meena' is the spouse of 'Gopal'. 'Ganpat' is the father of 'Meena'. Who is the granddaughter of 'Ram'?**

- (a) Hari
- (b) Mala
- (c) Meena
- (d) Shalaka

**Answer: B**

**Explanation:**

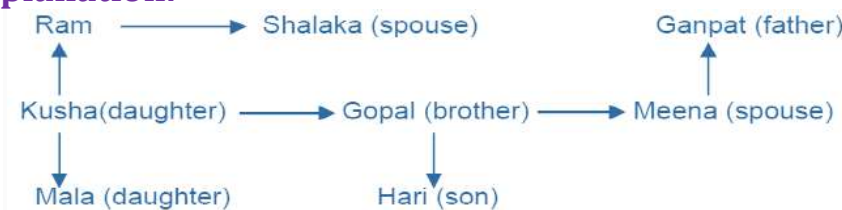

'Mala' is the daughter of 'Kusha' and 'Ram' is the father of 'Kusha'. So, 'Mala' is the granddaughter of 'Ram'. Hence,

**Question 28**

Pointing to a gentleman, Dinesh said "His only brother is the father of my daughter's father." How is the gentleman related to Dinesh?

- (a) Uncle
- (b) Grandfather
- (c) Father
- (d) Brother- in-law

**Answer: A**

**Explanation:**

The gentleman's only brother is the father of Dinesh (Dinesh daughter's father is Dinesh himself.). Gentleman is brother of Dinesh's father. Gentleman is Dinesh's uncle. Hence,

**Question 29**

Pointing to Ajay, Radha said, "His father is the only son of my grandfather". How is Radha Related to Ajay?

- (a) Brother
- (b) Sister
- (c) Mother
- (d) Daughter

**Answer: B**

**Explanation:**

Traditional Method

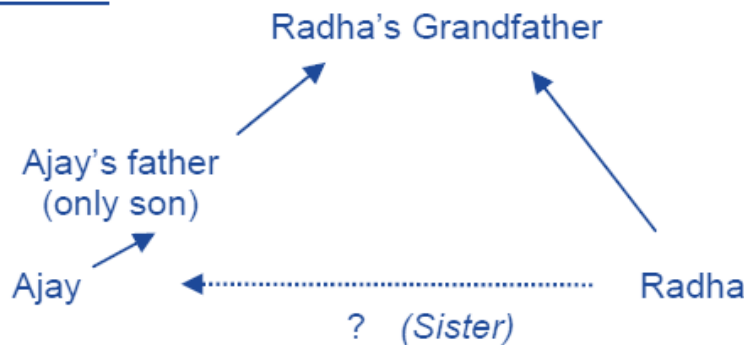

When Radha's Grandfather's only son is Ajay's father, then Ajay's father is also the father of Radha. So Radha is Ajay's sister. Hence, **answer is (B) Sister**. We know, 'Only son of my grandfather' means 'my father'. "His father is the only son of my grandfather" thus becomes "His father is my father". So Radha is Ajay's sister. Hence,

**Question 30**

Lalita said to Tina, "You are the daughter-in-law of the grandmother of my father's only son." How is Lalita related to Tina?

- (a) Aunt
- (b) Sister

(c) Mother

(d) Indeterminable

**Answer: D**

**Explanation:**

'My father's only son' is my (Lalita's) brother. Tina is daughter-in-law of grandmother of (Lalita's) brother. Tina thus can be their mother (wife of grandmother's only son). However, as it is not mentioned that the grandmother has only one son, Tina can be wife of grandmother's other son i.e. Tina could also be their aunt. Hence,

### **Question 31**

**Pointing to a photograph, Amar said, "I have no brother or sister but that man's father is my father's son." Whose photograph, was it?**

(a) a. His son's

(b) b. His father's

(c) c. His nephew's

(d) d. His own

**Answer: A**

**Explanation:**

Since Amar has no brother or sister so his father's son is the man himself and so the man who is talking is the father of the man in the photograph i.e. the man in the photograph is his son. Hence, **answer is (A) His son's.**

### **Question 32**

**Looking at the portrait of a man, Ashok said, 'His mother is the wife of my father's son. Brothers and sisters I have none'. At whose portrait was Ashok looking?**

(a) a. His cousin

(b) b. His nephew

(c) c. His uncle

(d) d. His son

**Answer: D**

**Explanation:**

My (Ashok's) father's son will be Ashok himself as he has no brother or sister. Ashok's wife is mother of the person in the portrait. The portrait is thus of Ashok's own son. Hence, **answer is (D) His Son.**

### **Question 33**

**Pointing to a photograph of a boy Suresh said, "He is the son of the only son of my mother." How is Suresh related to that boy?**

(a) Brother

(b) Uncle

(c) Cousin

(d) Father

**Answer: D**

**Explanation:**

The boy in the photograph is the only son of the son of Suresh's mother i.e., the son of Suresh. Hence, Suresh is the father of boy.

**Question 34**

**When Anuj saw Manish, he recalled, "He is the son of the father of my daughter." Who is Manish?**

- (a) Brother-in-law
- (b) Brother
- (c) Cousin
- (d) Uncle

**Answer: A**

**Explanation:**

Anuj's daughter's mother — Anuj's wife;  
Anju's wife's father - Anuj's father-in-law;  
Father-in-law's son — Anuj's brother-in-law  
So, Manish is Anuj's brother-in-law

**Question 35**

**A has 3 children. B is the brother of C and C is the sister of D, E who is the wife of A is the mother of D. There is only one daughter of the husband of E. What is the relation between D and B?**

- (a) A
- (b) B
- (c) C
- (d) D

**Answer: D**

**Explanation:**

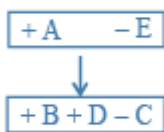

With the chart Therefore, D is a boy because there is only one daughter of E. Hence, B is the brother of D.

Note: While solving the question (+) can be used for male and (-) can be used for female.

**Question 36**

**If A + B means A is the mother of B; A x B means A is the father of B; A \$ B means A is the brother of B and A @ B means A is the sister of B, then which of the following means P is the son of Q?**

- (a) a. Q + R @ P @ N
- (b) b. Q + R \$ P @ N
- (c) c. Q x R \$ P @ N
- (d) d. Q + R \$ P \$ N

**Answer: D**

**Explanation:**

Q + R = Q is the mother of R  
R \$ P = R is the brother of P  
P \$ N = P is the brother of N  
Therefore, P is the son of Q.

**Question 37**

There are six persons playing cricket namely U, V, W, X, Y and Z. U and Y are brothers. Z is the sister of Y. W is the only son of U's uncle. V and X are the daughters of the brother of W's father. How is W related to Z?

- (a) Cousin
- (b) Father
- (c) Mother
- (d) wife

**Answer: A**

**Explanation:**

Z is Y's sister and hence U's sister, which means W is also the son of Z's uncle. So, W is Z's cousin.

**Question 38**

X - Z means X is the mother of Z;  $X \times Z$  means X is the father of Z and  $X + Z$  means X is the daughter of Z. Now, if  $M - N \times T + Q$ , then which of the following is not true?

- (a) T is N's daughter.
- (b) N is wife of Q
- (c) M is mother-in-law of Q
- (d) Q is wife of N.

**Answer: B**

**Explanation:**

$M - N \times T + Q$

M is the mother of N who is the father of T who is the daughter of Q. So, M is the grandmother of the daughter of Q, i.e., M is the mother-in-law of Q.

Hence (B) is not true.

**Question 39**

If ' $A \times B$ ' means 'B is father of A', ' $A + B$ ' means 'A is wife of B' and ' $A \div B$ ' means 'A is brother of B', then, what is the relation of J with L in ' $J + H \div R \times L$ '?

- (a) Daughter
- (b) Daughter-in-law
- (c) Sister-in-law
- (d) Cannot be determined

**Answer: B**

**Explanation:**

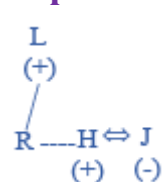

J is R's brother's wife. L is the father of H and R.

Hence, J is daughter-in-law of L.

**Question 40**

**A is B's sister. C is B's mother. D is C's father. E is D's mother. Then, how is A related to D?**

- (a) a. Grandfather (b) b. Grandmother  
(c) c. Daughter (d) d. Granddaughter

**Answer: D**

**Explanation:**

A is the sister of B and B is the daughter of C.  
So, A is the daughter of C. Also, D is the father of C.  
So, A is the granddaughter of D.

**Question 41**

**P is the brother of Q and R. S is R's mother. T is P's father. Which of the following statements cannot be definitely true?**

- (a) a. T is Q's father (b) b. S is P's mother  
(c) c. P is S's son (d) d. Q is T's son

**Answer: D**

**Explanation:**

P, Q, R are children of same parents. So, S who is R's mother and T, who is R's father will be mother and father of all three.  
However, it is not mentioned whether Q is male or female So, D cannot be definitely true.

**Question 42**

**Pointing to a person, a man said to a woman, "His mother is the only daughter of your father." How was the woman related to the person?**

- (a) Aunt (b) Mother  
(c) Wife (d) Daughter

**Answer: A**

**Explanation:**

Daughter of your father — Your sister. So, the person's mother is woman's sister or the woman is person's aunt.

**Question 43**

**A girl introduced a boy as the son of the daughter of the father of her uncle. The boy is girl's**

- (a) a. Brother (b) b. Son  
(c) c. Uncle (d) d. Son-in-law

**Answer: A**

**Explanation:**

Daughter of uncle's father — Uncle's sister — Mother;  
Mother's son — Brother

**Question 44**

**Pointing out to a lady, a girl said, "She is the daughter-in-law of the grandmother of my father's only son." How is the lady related to the girl?**

- (a) Sister-in-law (b) Mother  
(c) Aunt (d) Can't be determined

**Answer: D**

**Explanation:**

Girl's father's only son— Girl's brother. Daughter in law of girl's grandmother can be their mother, or maternal uncle's wife, i.e. aunt. So relation cannot be determined.

**Question 45**

**Pointing to a lady, a man said, "The son of her only brother is the brother of my wife." How is the lady related to the man?**

- (a) Mother's sister (b) Grandmother  
(c) Mother-in-law (d) Sister of father-in-law

**Answer: D**

**Explanation:**

Brother of my wife — My brother.in-law; Son of lady's brother is the brother-in-law of the man.

So lady's brother is man's father-in-law

i.e., the lady is the sister of man's father-in-law.

**Question 46**

**A woman introduces a man as the son of the brother of her mother. How is the man, related to the woman?**

- (a) Nephew (b) Son  
(c) Cousin (d) Uncle to Grandson

**Answer: C**

**Explanation:**

Brother of mother — Uncle: Uncle's son — Cousin

**Question 47**

**In a family, there are six members A, B, C, D, E and F.**

**A and B are a married couple, A being the male member. D is the only son of C, who is the brother of A. E is the sister of D. B is the daughter-in-law of F, whose husband has died. How is E related to C?**

- (a) a. Sister (b) b. Daughter  
(c) c. Cousin (d) D. Mother



**Answer: B**

**Explanation:**

A is a male and married to B. So, A is the husband and B is the wife. C is the brother of A. D is the son of C. E. who is the sister of D will be the daughter of C. B is the daughter-in-law of F whose husband has died means F is the mother of A. Clearly, E is the daughter of C.

**Question 48**

**There are six persons A, B, C, D, E and F. C is the sister of F. B is the brother of E's husband. D is the father of A and grandfather of F. There are two fathers, three brothers and a mother in the group. Who is the mother?**

- |       |       |
|-------|-------|
| (a) A | (b) B |
| (c) C | (d) E |

**Answer: D**

**Explanation:**

D is father of A and grandfather of F. So, A is father of F. Thus, D and A are the two fathers. C is the sister of F So, C is the daughter of A. Since there is only one mother, it is evident that E is the wife of A and hence the mother of C and F. So, B is brother of A There are three brothers. So, F is the brother of C. Clearly, A is E's Husband.

**Question 49**

**Introducing a man, a woman said, 'He is the only son of my mother's mother.' How is the woman related to the man?**

- |            |           |
|------------|-----------|
| (a) Mother | (b) Aunt  |
| (c) Sister | (d) Niece |

**Answer: D**

**Explanation:**

My mother's mother — My grandmother: My grandmother's only son — My maternal uncle. So, the woman is man's niece.

## PAST EXAMINATION QUESTIONS:

MAY 2018

**Question 1**

**Vinod introduce Vishal as the son of the only brother of his father's wife. How is Vinod related to Vishal?**

- |            |             |
|------------|-------------|
| (a) Cousin | (b) Brother |
|------------|-------------|

(c) Son

(d) Uncle

**Answer: A**

Vinod introduces Vishal as the Son of the only brother of his father's wife then Vinod is cousin of Vishal.

**Question 2**

Suresh introduces a man as "he is the son of the woman who is the mother of the husband of my mother". How is Suresh related to the man?

(a) Brother-in-law

(b) Son

(c) Brother

(d) Nephew

**Answer: B**

Suresh introduces a man as "he is the son of the woman who is the mother of the husband of my mother". Then Suresh is the 'Son' the man.

**Question 3**

A reads a book and find the name of the author familiar. The author is the paternal uncle of C. C is the daughter of A. How is C related to A

(a) Brother

(b) Sister

(c) Father

(d) Uncle

**Answer: A**



**Question 4**

P and Q are brothers R and S are sisters. P's son is R's brother. How is Q related to R ?

(a) Uncle

(b) Brother

(c) Father

(d) Grandfather

**Answer: A**



As P is father of X and P is its brother so they are uncle and nephew. So, relationship between Q and R is of Uncle.

**NOV 2018**

**Question 1**

Pointing to a man in a photograph, a woman said, “the father of his brother is the only son of my grandfather”, how is the woman related to man in the photograph?

- (a) Mother
- (b) Aunty
- (c) Daughter
- (d) Sister

**Answer: D**

**Explanation:**

The father of his brother is the only son of my grandfather. So, the woman is man’s sister.

Only son of woman's grandfather = woman's father Man's brother's father-man's father so. The woman is man's sister.

**Question 2**

Six persons are seen together in a group. They are A, B, C, D, E and F, B is brother of D, but D is not brother of B. F is brother of B, C and A are married together. F is son of C, but C is not mother of F. E is brother of A. The number of female member in the group is

- (a) 1
- (b) 2
- (c) 3
- (d) 4

**Answer: B**



No. of female members = 2

**Question 3**

Ram and Mohan are brothers, Shankar is Mohan's father. Chhaya is Shankar's sister. Priya is Shankar's niece. Shubhra is Chhaya's granddaughter. Then Ram is Shubhra's.

- (a) Brother
- (b) Uncle
- (c) Cousin
- (d) Nephew

**Answer: B**



Ram is the uncle of Shubhra.

**Question 4**

If P + Q means P is the mother of Q. P ÷ Q means P is the father of Q. P-Q means P is the sister of Q. Then which of the following relationship shows that M is the daughter of R?

- (a) R + M+N
- (b) R + N +M
- (c) R - M+N
- (d) None of the above

**Answer: A**

M+N i.e., R is the father of M.  
Hence, R: M+N clearly means  
That, M is the daughter of R.

**MAY 2019**

**Question 1**

Pointing to a photograph, a Man said “His Mother husband’s sister is my aunt”. Then what is relation between a man and he?

- (a) Son
- (b) Uncle
- (c) Nephew
- (d) Brother

**Answer: D**

**Explanation:**

man’s mother husband = father  
So the answer be man’s Brother

**Question 2**

Pointing to old man Kailash said “his son is my son’s uncle” How is kailash is related to old man.

- (a) Brother
- (b) Either son (or) son-in-law
- (c) Father
- (d) Grand Father

**Answer: B**

**Explanation:**

So Kailash is related to old man is in terms of Father son relation.

**Question 3**

If A is the brother of B; B is the sister of C; and C is the father of D, how D is related to A?

- (a) Brother
- (b) Sister
- (c) Nephew
- (d) Cannot be determined

**Answer: D**

**Explanation:**

If D is Male, the answer is Nephew. If D is Female, the answer is Niece. As the sex of D is not known, hence, the relation between D and A cannot be determined. Note: Niece - A daughter of one's brother or sister, or of one's brother-in-law or sister-in-law. Nephew - A son of one's brother or sister, or of one's brother-in-law or sister-in-law.

**Question 4**

**A is the son of C; C and Q are sisters; Z is the mother of Q and P is the son of Z. Which of the following statements is true?**

- (a) P and A are cousins (b) P is the maternal uncle of A  
(c) Q is the maternal grandfather of A (d) C and P are sisters

**Answer: B**

**Explanation:**

C and Q are sisters and A is the son of C. Hence, C is the mother of A or Z is the mother Q. Hence, Z is the maternal grandmother of A. P is the son of Z. Hence, P is the maternal uncle of A.

**NOV 2019**

**A, B, C, D, E and F are members of a family. B is the son of A DUE the mother of B, A and C are married couple. F is the brother of A. D is the sister of B, E is the son of C.**

**Question1**

**How many male members are there in the family.**

- (a) 1 (b) 2  
(c) 3 (d) 4

**Q.2 How is F related to B?**

- (a) Uncle (b) Daughter  
(c) Son (d) Niece

**Q.3 How many children A has?**

- (a) 3 (b) 2  
(c) 4 (d) 1

**Answer:**

For question [1-3]

(+) => male

(-) => female

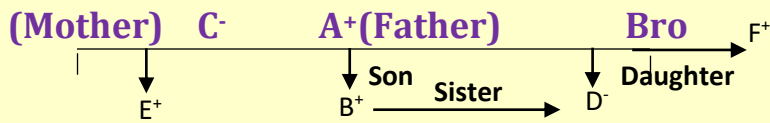

**Q.1 (Ans.)** (d) There are four male members in the family i.e.

A (father or husband)

F (A's brother)

B (son of A and C)

E (son of A and C)

**Q.2 (Ans.)** (a) Since F is A's brother and B is A's son. father's brother = uncle So, F is the uncle of B

**Q.3 (Ans.)** (a) A has 3 children E, B and D

## DEC 2020

### Question 1

**Pointing towards a person a man said to a woman. "His mother is the only daughter of your father". How is the woman related to that person?**

- (a) daughter (b) mother  
(c) sister (d) wife

**Answer: B**

**Explanation:**

The only daughter of the woman's father is she herself. So, the person is the woman's son. i.e., the woman is the person's mother. Hence, the answer is (b).

### Question 2

**Vicky introduces John as the son of the only brother of his father's wife. How is Vicky related to John?**

- (a) Cousin (b) Son  
(c) Brother (d) Uncle

**Answer: A**

**Explanation:**

The only brother of his father's wife is Sohan's maternal uncle. So, Mohan is Sohan's maternal uncle's son.

So, Mohan is Sohan's cousin.  
Option A.

### **Question 3**

**Point out to a lady sohil said she is the daughter of woman. Who is the mother of the husband of my mother? Who is the lady to sohil?**

- (a) Sister (b) Aunt  
(c) Daughter (d) Sister-in-law

**Answer: B**

#### **Explanation:**

The relations may be analyzed as follows:

Mother's husband ⇒ Father;

Father's mother ⇒ Grandmother;

Grandmother's daughter ⇒ Father's sister;

Father's sister ⇒ Aunt.

So, the lady is Rajan's aunt.

Hence, the answer is (b).

## **JAN 2021**

### **Question 1**

**P is the brother of Q and R, S is the mother of R. T is the father of P. which of the following statements cannot be definitely true?**

- (a) S is the mother of P (b) P is son of S  
(c) T is husband of S (d) Q is son of T.

**Answer: D**

#### **Explanation:**

P, Q, R are children of same parents. So, S who is R's mother and T, who is R's father will be mother and father of all three. However, it is not mentioned whether Q is male or female So, D cannot be definitely true.

### **Question 2**

**Pointing to a lady in a photograph, Ran said, "her son's father is the son-in-law of my mother," how is Ram related to the lady?**

- (a) Aunt (b) Cousin  
(c) Sister (d) Mother

**Answer: B**

#### **Explanation:**

Ram is brother of that lady.

### **Question 3**

**A girl introduces ..... a boy as the son of the daughter of the father of her uncle the boy is girl's**

- (a) Son (b) Brother  
(c) Son-in-law (d) Uncle

**Answer: B**

**Explanation:**

Daughter of uncle's father — Uncle's sister — Mother; Mother's son — Brother

**Question 4**

**Pointing to lady, Sahil said “She is the daughter of the woman who is the mother of the husband of my mother, “who is the lady to Sahil?**

- (a) Aunt (b) Sister  
(c) Daughter (d) Sister – in – law

**Answer: A**

**Explanation:**

The relations may be analyzed as follows:

Mother's husband ⇒ Father;

Father's mother ⇒ Grandmother;

Grandmother's daughter ⇒ Father's sister;

Father's sister ⇒ Aunt.

**So, the lady is Rajan's aunt. Hence, the answer is (a).**

**JULY 2021**

**Question 1**

**Pointing towards “A”, “B”, said: “Your mother is younger sister of my mother”. “A” is related to “B” as\_\_**

- (a) Uncle (b) Cousin  
(c) Nephew (d) Father

**Answer: Options (b)**

**Explanation:**

Pointing towards A, B said “your mother is the younger sister of my mother”

We draw the flow chart of given information as follows, circle around the alphabet indicates that person is a lady

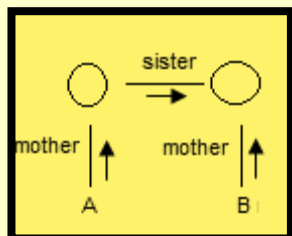

A is the cousin of B. So b is the answer

**Question 2**



**Shyam's mother said to Shyam "my mother has a son whose son is Ram". Shyam is related to Ram as \_**

- (a) Uncle (b) Cousin  
(c) Nephew (d) Grandfather

**Answer: Options (b)**

**Question 3**

**Amit said "This girl is the wife of the grandson of my mother". How Amit related to the girl?**

- (a) Father-in-law (b) Grandson  
(c) Father (d) Son

**Answer: Options (a)**

**Explanation:**

The grand-son of Amit's mother mean his son.  
So, the wife of his son is daughter-in-law to him.  
Therefore, Amit is the father-in-law of the girl.

**Question 4**

**A is the son of C; C and Q are sisters; Z is the mother of Q and P is the son of Z. Which of the following statements is true?**

- (a) A and P are cousins (b) C and P are sisters  
(c) P is the maternal uncle of A (d) A is the maternal uncle of P

**Answer: Options (c)**

**Explanation:**

C and Q are sisters and A is the son of C.  
C is the mother of A and Z is the mother Q.  
Hence, Z is the matemal grandmother of A.  
P is the son of Z.  
Hence, P is the material uncle of A.

**DEC 2021**

**Question 1**

**D is daughter of E. A is son of D. C is a brother of A and B is the sister of A. F is the brother of D. How F is related to B?**

- (a) Father-in-law (b) Brother  
(c) Uncle (d) Mother-in-law

**Answer: c**

**Explanation:**

Let me be B. Since I'm the sister of A, A is my brother. Since A (my brother) is the son

of D, D is my mother. Since F is the brother of D (my mother), F is my maternal uncle.

**Question 2**

**Introducing a boy a girl said, "He is the son of the daughter of the father of my uncle". Who is the boy to the girl?**

- (a) Brother (b) Nephew  
(c) Uncle (d) Son-in-law

**Answer: a**

**Explanation:**

Let me be the girl introducing the boy. If the uncle is paternal, then the father of my uncle would be my grandfather (Dadaji), and hence his daughter would be my aunt (Bua). Son of my Bua would be my cousin. However, cousin is not in the options.

If the uncle is maternal, then the father of my uncle would be my grandfather (Nanaji), and hence his daughter could either be my Mother, or my Aunt (Mausi). Again, if the daughter is my Aunt, then her son would be my cousin, and cousin is not in the options. If the daughter is my Mother, then her son would be my brother.

Therefore, option (a) is the answer.

**Question 3**

**It is given that 'A is the mother of B; B is the sister of C; C is the father of D'. How is A related to D?**

- (a) Mother (b) Grandmother  
(c) Aunt (d) Sister

**Answer: b**

**Explanation:**

Let me be D. C is my father. B, my father's sister, is my Aunt. A, my aunt's mother, would be my Grandmother.

**Question 4**

**R told to M as, "the girl, I met at the beach, was the youngest daughter of the brother-in-law of my friend's mother". How is the girl related to R's friend?**

- (a) Cousin (b) Daughter  
(c) Niece (d) Aunt

**Answer: a**

**Explanation:**

Let me be R's friend. Now, my mother's brother-in-law would be either my paternal uncle, or my maternal aunt's husband. Either way, the daughter would be my cousin.

**Question 5**

**P,Q, R, S, T, U are 6 members of a family in which there are two married couples. T, a teacher is married to a doctor who is mother of R and U. Q the lawyer is married to P. P has one son and one grandson. Of the two married ladies one is a housewife. There is also one student and one male engineer in the family.**

**Which of the following is true about the granddaughter of the family?**

- (a) She is a lawyer
- (b) She is an engineer
- (c) She is a student
- (d) She is a doctor

**Answer: c**

**Explanation:**

The family tree is as follows:

Q is the male lawyer married to P who is a housewife. They have a son, T, who is a teacher. T is married to S, who is a doctor. They have two children - R and U. Out of them, one is a male engineer, and the other is a student.

Therefore, the granddaughter of the family is a student.

**Question 6**

**X and Y are brothers. R is the father of Y. S is the brother of T and maternal uncle of X. What is T to R?**

- (a) Mother
- (b) Wife
- (c) Sister
- (d) Brother

**Answer: b**

**Explanation:**

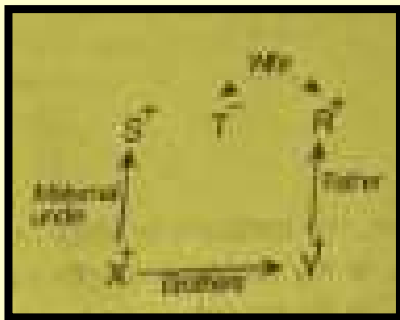

T is the wife of 'R'

**JUNE 2022**

**Question 1**

**Ravi is son of Aman's father's sister. Ram is son of Divya. Who is the mother of Gourv and grandmother of Aman. Ashok is father of Tanya and grandfather of Ravi. Divya is wife of Ashok. How is Ravi related to Divya?**

- (a) Nephew
- (b) Grandson
- (c) Son
- (d) None

**Answer: Options (b)**

**Explanation:**

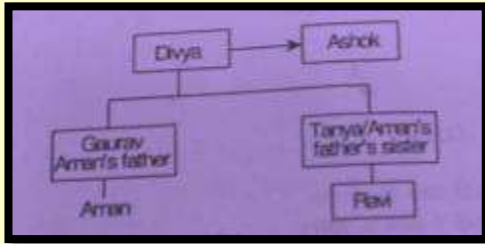

Ravi is the grandson of Divya.

**Question 2**

**P + Q means P is brother of Q, P - Q means P is the mother of Q, P × Q means P is the sister of Q. Which of the following means M is the maternal uncle of R?**

- (a)  $M + K + R$
- (b)  $M - R + K$
- (c)  $M + K - R$
- (d)  $M + K \times R$

**Answer: Options (c)**

**Explanation:**

$P + Q$  means 'P' is the brother of 'Q'

$P - Q$  means 'P' is the mother of 'Q'

$P \times Q$  means 'P' is the sister of 'Q'

$M + K - R$

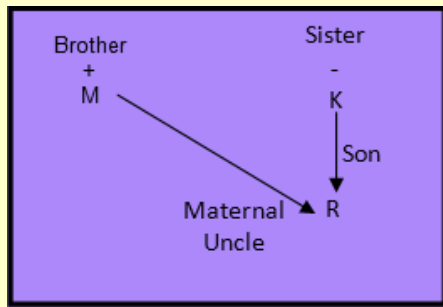

M is the Maternal uncle if R

**Question 3**

**A women going with a boy is asked by another women about the relationship between them, The women replied " My maternal uncle and the uncle are his maternal uncle are same", the relationship between the lady and the boy is \_**

- (a) Maternal grandmother and grandson
- (b) Mother and son
- (c) Father and son
- (d) Paternal grandmother and grandson

**Answer: Options (b)**

**Explanation:**

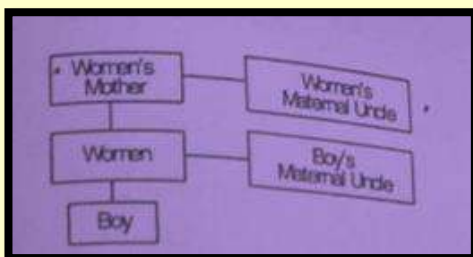

The Relationship b/w the lady and the boy is mother and son

**Question 4**

If Kamal says, "Ravi's mother is the only daughter of my mother. How is Kamal related to Ravi?"

- (a) Father
- (b) Grandmother
- (c) Son
- (d) Maternal uncle

**Answer: Options (d)**

**Explanation:**

Only daughter of Komal's mother – Komal's sister  
So, Ravi's mother is komal's sister or Komal is the brother of Ravi's mother i.e. Komal is Ravi's Maternal Uncle

**Question 5**

A is B's sister. C is B's mother. D is C's father. E is D's mother. Then how A is related to D?

- (a) Grandfather
- (b) Grandmother
- (c) Daughter
- (d) Grand daughter

**Answer: Options (a)**

**Explanation:**

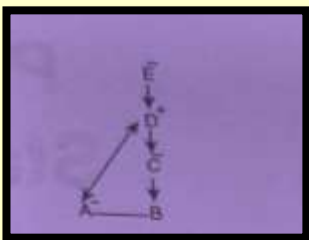

∴ D is the father of C and D is the grandfather of A.

**Question 6**

If A \$ B means A is father of B. A # B means A is daughter of B. A @ B means A is sister of B. Then how is K related to M H @ K \$ L # M

- (a) Husband
- (b) Uncle
- (c) Father
- (d) Grandson

**Answer: Options (a)**

**Explanation:**

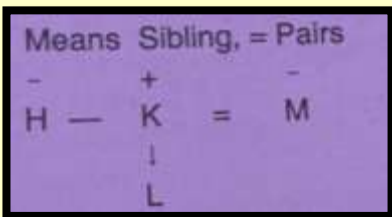

K is the husband of M