

CHAPTER – 10

DIRECTION SENSE TEST

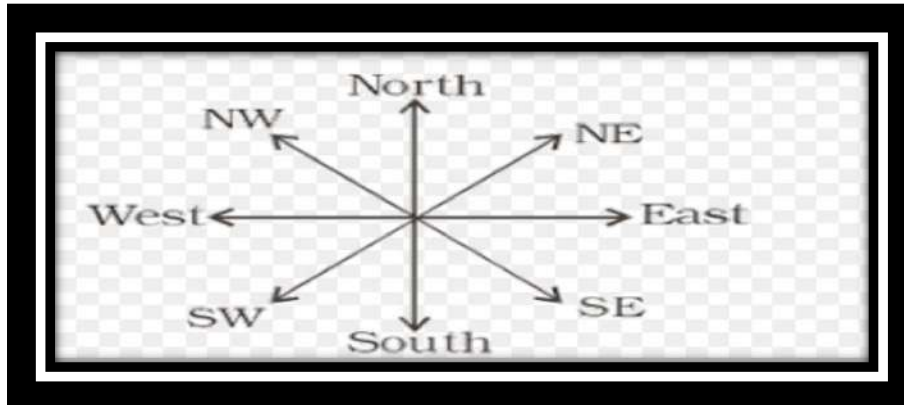

Always Remember

LEFT & LEFT	Down
RIGHT & LEFT	UP
LEFT & RIGHT	UP
RIGHT & RIGHT	Down
UP & LEFT	Left
UP & RIGHT	Right
DOWN & LEFT	Right
DOWN & RIGHT	Left



Question1

One morning Udai and Vishal were talking to each other face to face at a crossing. If Vishal's shadow was exactly to the left of Udai, which direction was Udai facing?

- (a) East. (b) West
(c) North (d) South

Answer: C

Explanation:



Question2

Y is in the East of X which is in the North of Z. If P is in the South of Z, then in which direction of Y, is P?

- (a) North
- (b) South
- (c) South-East
- (d) None of these

Answer: D

Explanation:

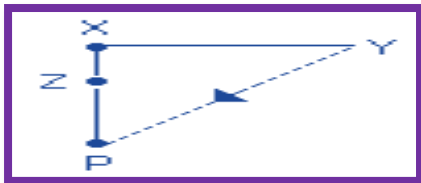

P is in South-West of Y

Question 3

If South-East becomes North, North-East becomes West and so on. What will West become?

- (a) North-East
- (b) North-West
- (c) South-East
- (d) South-West

Answer: C

Explanation:



It is clear from the diagrams that new name of West will become South-East

Question4

A man walks 5 km toward south and then turns to the right. After walking 3 km he turns to the left and walks 5 km. Now in which direction is he from the starting place?

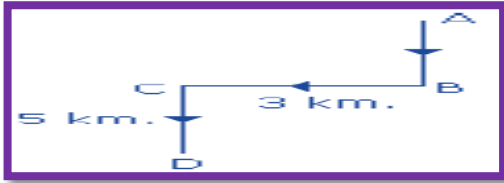

- (a) North-East
- (c) South-East

- (b) North-West
- (d) South-West.

Answer: D

Explanation

Hence required direction is South-West.

Question5

Rahul put his timepiece on the table in such a way that at 6 P.M. hour hand points to North. In which direction the minute hand will point at 9.15 P.M.?

- (a) South-East
- (c) North

- (b) South
- (d) West

Answer: D

Explanation:

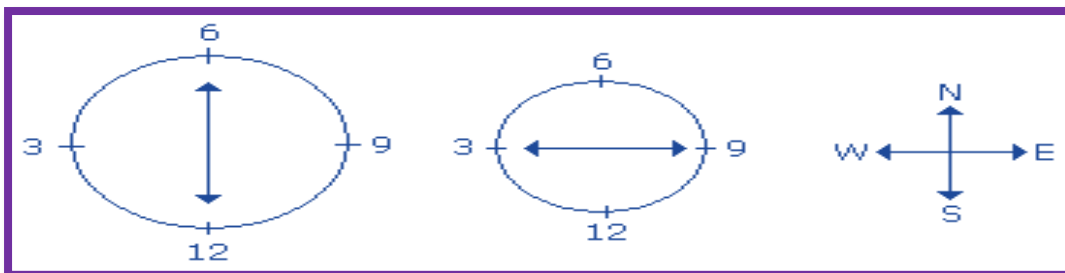

At 9.15 P.M., the minute hand will point towards west

Question6

Two cars start from the opposite places of a main road, 150 km apart. First car runs for 25 km and takes a right turn and then runs 15 km. It then turns left and then runs for another 25 km and then takes the direction back to reach the main road. In the meantime, due to minor break down the other car has run only 35 km along the main road. What would be the distance between two cars at this point?

- (a) 65 km

- (b) 75 km

(c) 80 km

(d)85 km

Answer: A

Explanation:

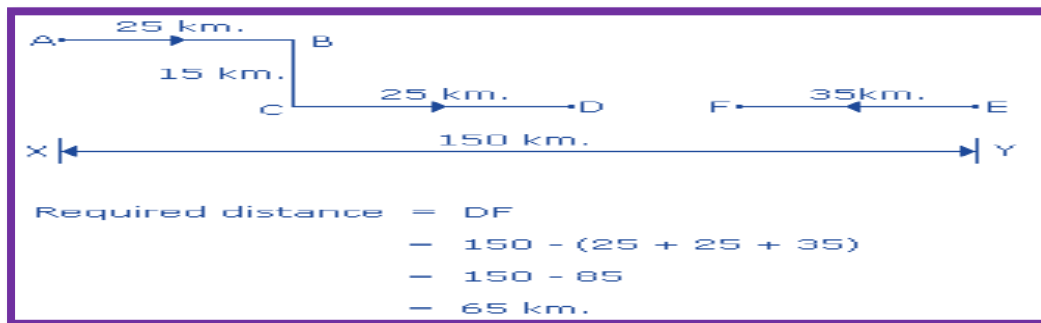

Question 7

Starting from the point X, Jayant walked 15 m towards west. He turned left and walked 20 m. He then turned left and walked 15 m. After this he turned to his right and walked 12 m. How far and in which directions is now Jayant from X?

(a)32 m, South

(b) 47 m, East

(c) 42 m, North

(d)27 m, South

Answer: A

Explanation:

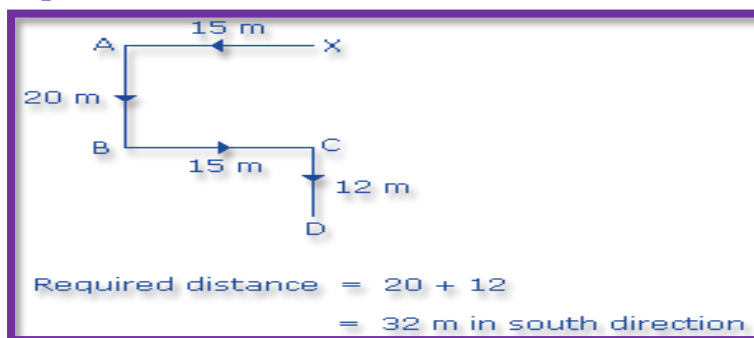

Question 8

One evening before sunset Rekha and Hema were talking to each other face to face. If Hema's shadow was exactly to the right of Hema, which direction was Rekha facing?

(a)North

(b) South

(c) East

(d)Data is inadequate

Answer: B

Explanation:



In the evening sun sets in West. Hence then any shadow falls in the East. Since Hema's shadow was to the right of Hema. Hence Rekha was facing towards South.

Question 9

A boy rode his bicycle Northward, then turned left and rode 1 km and again turned left and rode 2 km. He found himself 1 km west of his starting point. How far did he ride northward initially?

- (a) 1 km
- (b) 2 km.
- (c) 3 km
- (d) 5 km

Answer: B

Explanation:

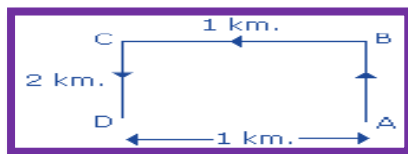

The boy rode 2 km. Northward.

Question 10

K is 40 m South-West of L. If M is 40 m South-East of L, then M is in which direction of K?

- (a) East
- (b) West
- (c) North-East
- (d) South

Answer: A

Explanation:

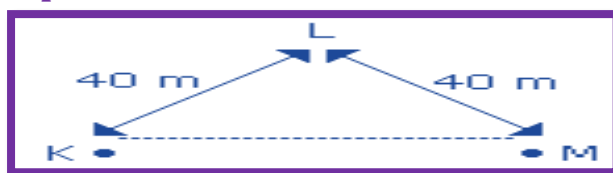

Hence M is in the East of K.

Question 11

A man walks 2 km towards North. Then he turns to East and walks 10 km. After this he turns to North and walks 3 km. Again he turns towards East and walks 2 km. How far is he from the starting point?

- (a) 10 km
- (b) 13 km
- (c) 15 km
- (d) None of these

Answer: B

Explanation:

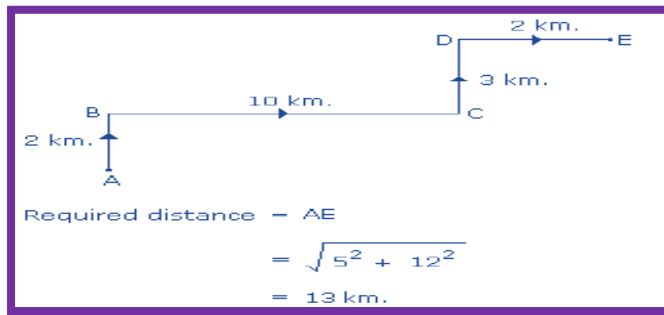

Question 12

The length and breadth of a room are 8 m and 6 m respectively. A cat runs along all the four walls and finally along a diagonal order to catch a rat. How much total distance is covered by the cat?

- (a) 10
- (b) 14
- (c) 38
- (d) 48

Answer: C

Explanation:

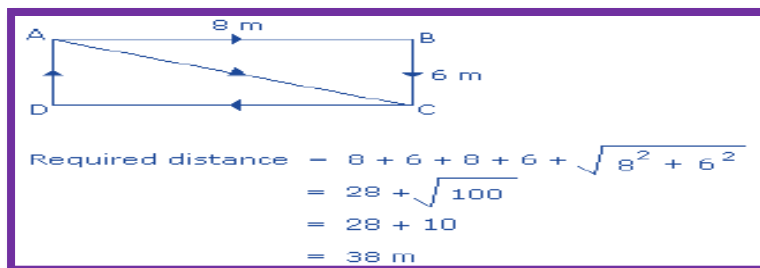

Question 13

One morning sujata started to walk towards the Sun. After covering some distance, she turned to right then again to the right and after covering some distance she again turns to the right. Now in which direction is she facing?

- (a) North
- (b) South
- (c) North-East
- (d) South-West

Answer: A

Explanation:

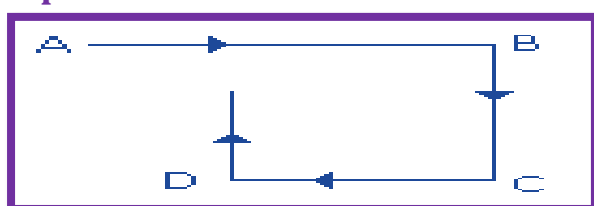

Hence finally Sujata will face towards North.

Question14

Some boys are sitting in three rows all facing north such that A is in the middle row. P is just to the right of A but in the same row. Q is just behind of P while R is in the North of A. In which direction of R is Q?

- (a) North
- (b) South- East
- (c) North-East
- (d) South-West

Answer: b

Explanation:

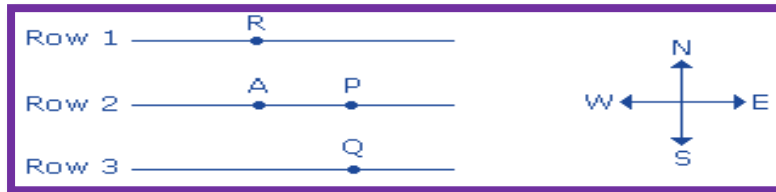

Q is in South-East of R

Question15

One morning after sunrise, Vimal started to walk. During this walking he met Stephen who was coming from opposite direction. Vimal watch that the shadow of Stephen to the right of him (Vimal). To Which direction Vimal was facing?

- (a) East
- (b) West
- (c) South
- (d) Data inadequate

Answer: C

Explanation:

Sun rises in the east. So the shadow of a man will always falls towards the west. Since the shadow of Stephen is to the right of Vimal. Hence Vimal is facing towards South.

Question 16

Golu started from his house towards North. After covering a distance of 8 km. he turned towards left and covered a distance of 6 km. What is the shortest distance now from his house?

- (a) 10 km
- (b) 14 km
- (c) 14 km
- (d) 2 km

Answer: A

Explanation:

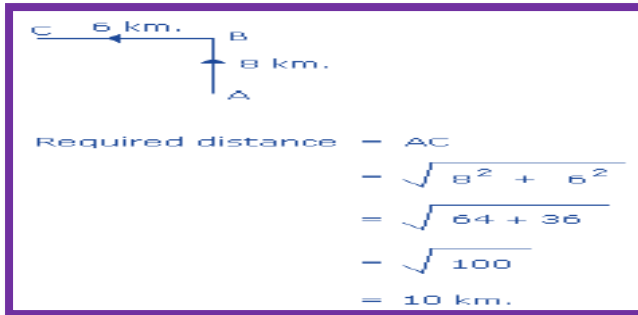

Question 17

P started from his house towards west. After walking a distance of 25 m. He turned to the right and walked 10 m. He then again turned to the right and walked 15 m. After this he is to turn right at 135° and to cover 30 m. In which direction should he go?

- (a) West
- (b) South
- (c) South-West
- (d) South-East

Answer: C

Explanation:

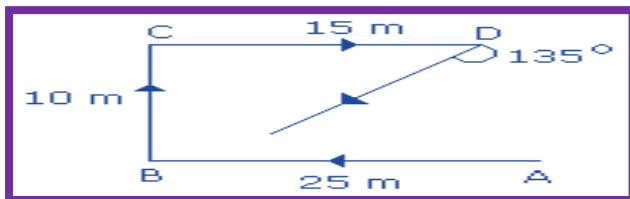

Hence he should go in the South-West direction.

Question 18

X-Men started to walk straight towards south. After walking 5 m he turned to the left and walked 3 m. After this he turned to the right and walked 5 m Now to which direction X is facing?

- (a) North-East
- (b) South
- (c) North
- (d) South-West

Answer: B

Explanation:

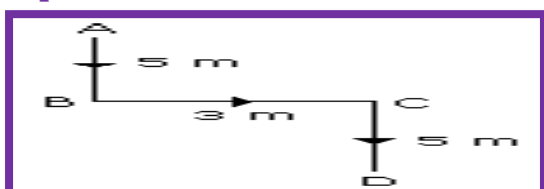

Hence X-Men will face in the end towards South.

Question 19

Hemant in order to go to university started from his house in the east and came to a crossing. The road to the left ends in a theatre, straight ahead is the hospital. In which direction is the university?

- (a) North (b) South
(c) East (d) West

Answer:A

Explanation:

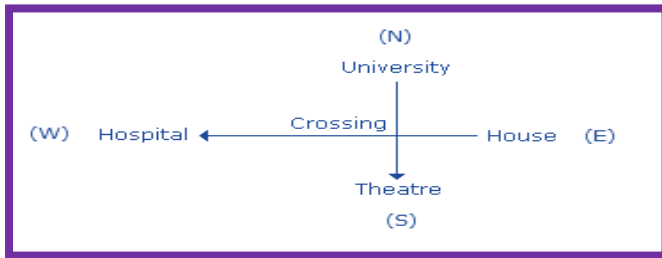

Therefore, university is in North

Question 20

If a boy starting from Nileshe, met to Ankur and then to Kumar and after this he to Dev and then to Pintu and whole the time he walked in a straight line, then how much total distance did he cover?

- (a) 215 m (b) 155 m
(c) 245 m (d) 185 m

Answer:A

Explanation:

Required distance = 25 m + 40 m + 60 m + 90 m

Required distance = 215 m

Question 21

Each of the following questions is based on the following information: Six flats on a floor in two rows facing North and South are allotted to P, Q, R, S, T and U.

Q gets a North facing flat and is not next to S.

S and U get diagonally opposite flats.

R next to U, gets a south facing flat and T gets North facing flat.

If the flats of P and T are interchanged, then who's flat will be next to that of U?

- (a) P (b) Q
(c) R (d) T

Answer: C

Explanation:

Hence flat R will be next to U.

Question22

Which of the following combination get south facing flats?

- (a) QTS
- (b) UPT
- (c) URP
- (d) Data is inadequate

Answer:C

Explanation:

Hence URP flat combination get south facing flats.

Question23

Rasik walked 20 m towards north. Then he turned right and walks 30

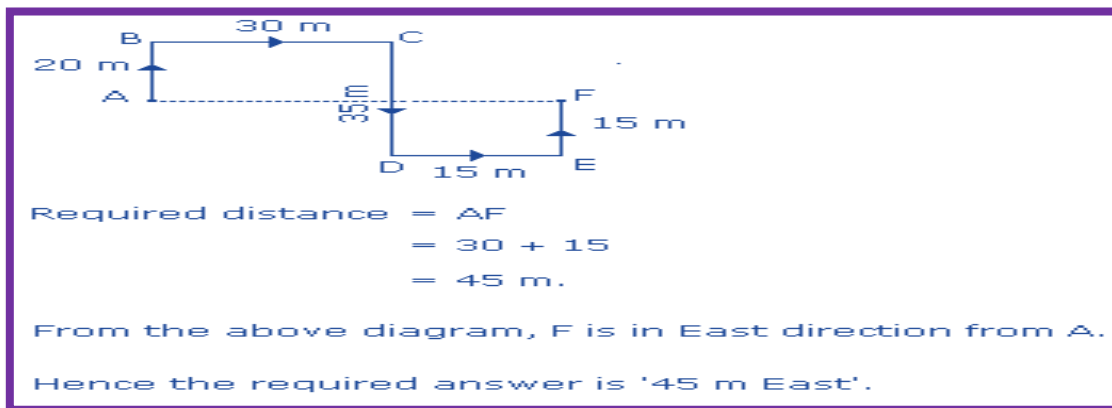

m. Then he turns right and walks 35 m. Then he turns left and walks 15 m. Finally, he turns left and walks 15 m. In which direction and how many meters is he from the starting position?

- (a) 15 m West
- (b)
- (c) 30 m West
- (d)

Answer: D

Explanation:

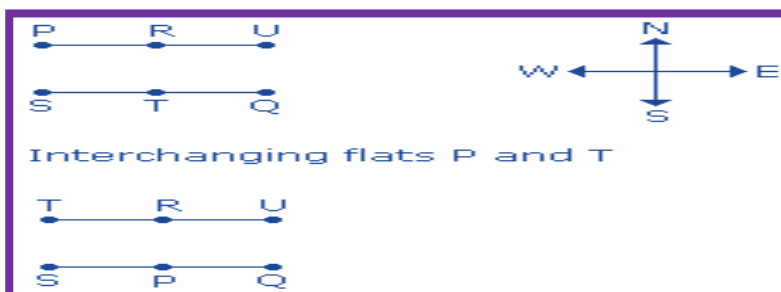

Question 24

Eight persons M through T are standing in such a way that O is 20 m apart from N towards West, N is 30 m South with respect to M. M is 40 m towards West with respect to Q. P is 50 m towards South with respect to Q. R is 15 m apart from S towards North. T is 20 m towards East with respect to S. R is 40 m towards West with respect to P .In which direction is Q standing with respect to R?

- (a) North-West (b) North
(c) North-East (d) Cannot be determined

Answer: C

Explanation:

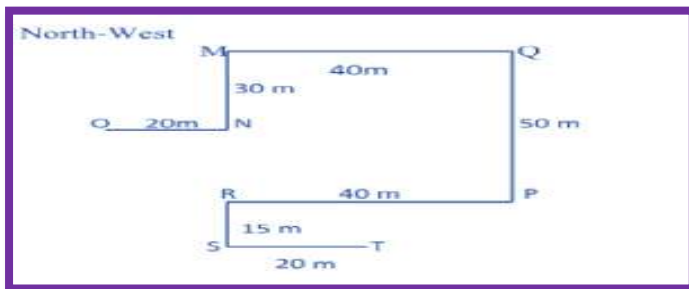

Question 25

Two buses start from the opposite points of a main road, 150km apart. The first bus runs for 25 km and takes a right turn and then runs for 15km. It then turns left and runs for another 25km and takes the direction back to reach the main road. In the meantime, due to the minor break down the other bus has run only 35km along the main road. What would be the distance between the two buses at this point?

- (a) 65km (b) 80km
(c) 75km (d) 85km

Answer: A

Explanation:

Required distance = PQ = 150 - (25 + 25 + 35) = 65km

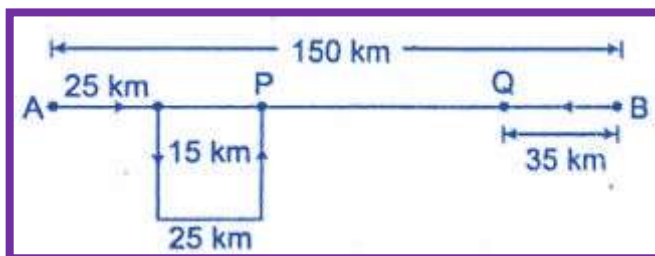

Question 26

Mohan walked 30m towards South, took a left turn and walked 15m. He, then took a right turn and walked 20m. He again took a right turn and walked 15m. How far is he from the starting point?

- (a) 95m (b) 50m
(c) 70m (d) Cannot be determined

Answer: B

Explanation:

Required distance = OD = OA + AD = OA + BC

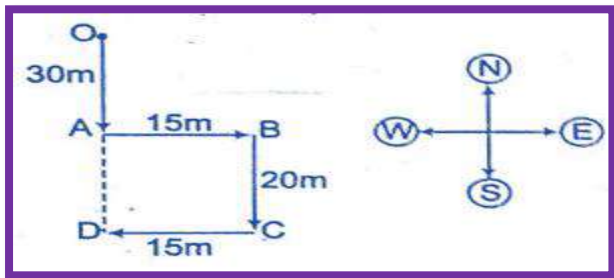

$$= 30 + 20 = 50\text{m}$$

Question 27

Starting from the point X, Jayant walked 15 m towards west. He turned left and walked 20 m. He then turned left and walked 15 m. After this he turned to his right a walked 12 m. How far and in which directions is now Jayant from X?

- (a) 32 m, South (b) 47 m, East
(c) 42 m, North (d) 27 m, South

Answer: A

Explanation:

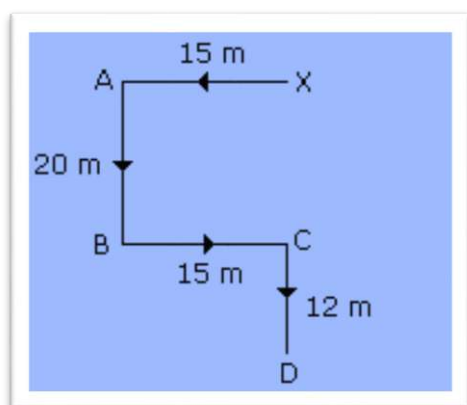

Question 28

Lakshman went 15 kms to the West of his house, then turned left and walked 20 kms. He then turned East and walked 25 kms and finally turning left covered 20 kms. How far was he from his house?

- (a) 15 kms (b) 20 kms

(c) 25kms

(d)10 kms

Answer: d

Explanation:

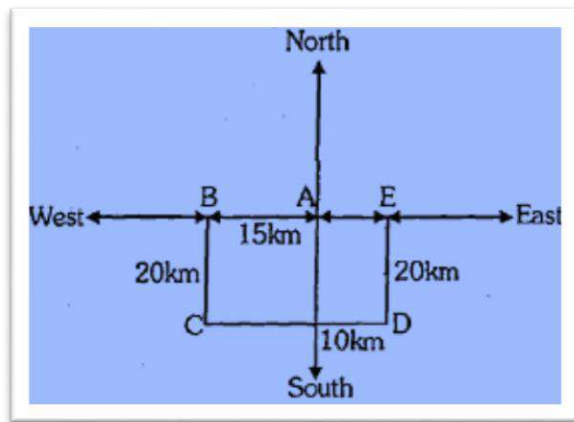

Question 29

A starts from a point and walks 5kms north, then turns left and walks 3kms. Then again turns left and walks 5kms. Point out the direction in which he is going.

(a) West

(b) South

(c) North

(d) East

Answer: b

Explanation:

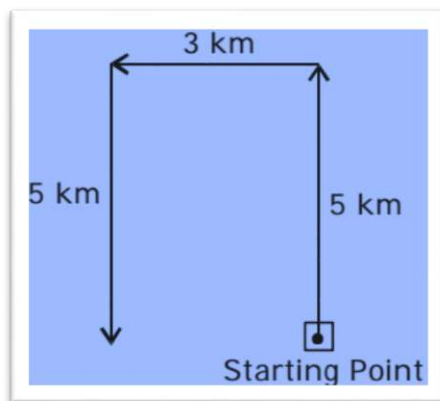

Question 30

A person walks 4 km towards west, then turns to his right to travel 9 km. He turns towards east and travels 12 km. Finally, he travels 3 km towards south. How far is he from the initial position (in km)?

(a) 15

(b) 23

(c) 18

(d) 10

Answer: d

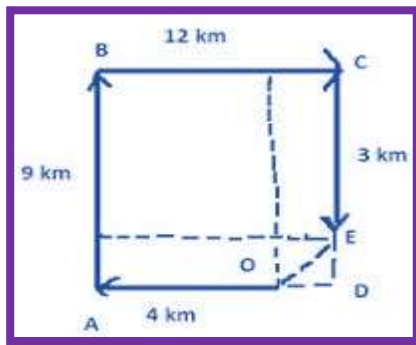

Explanation:

From the figure, the distance OE is to be calculated. In triangle ODE, $OE = \sqrt{(OD^2) + (DE^2)}$

$$= \sqrt{(BC - AO)^2 + (AB - CE)^2} \quad OE = \sqrt{(8^2 + 6^2)} = 10\text{km.}$$

Question31

One evening before sunset two friends Sumit and Mohit were talking to each other face to face. If Mohit’s shadow was exactly to his right side, which direction was Sumit facing?

- (a) North
- (b) south
- (c) West
- (d) Data inadequate

Answer: B

Explanation:

In the evening, sun is in the west and so the shadows fall towards east. Now, since Mohit’s shadow fell towards right, therefore, Mohit is facing North. So, Sumit standing face to face with Mohit, was facing South.

Question 32

A girl leaves from her home. She first walks 30 meters in North-west direction and then 30 meters in South-west direction. Next, she walks 30 meters in South-east direction. Finally, she turns towards her house. In which direction is she moving?

- (a) North-East
- (b) North-West
- (c) South-East
- (d) South-East

Answer: a

Explanation:

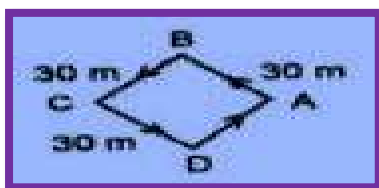

The movements of the girl are as shown in Fig. (A to B, B to C, C to D, D to A).

Clearly, she is finally moving in the direction DA i.e. north east.

Question33

A man goes towards East 5km, then he takes a turn to South-West and goes 5km. He again takes a turn towards North-West and goes 5km with respect to the point from where he started, where is he now?

- (a) At the starting point
- (b) In the West
- (c) In the East
- (d) In the North East

Answer: a

Explanation:

According to the question, the direction diagram is as follows

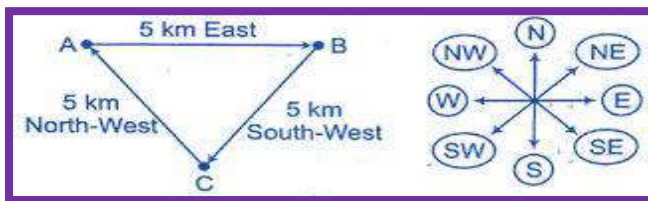

It is clear from the diagram that both starting and finishing point are same i.e. , the man is at starting point 'A'.

Question 34

Nikhil walked 30m towards East took a left turn and walked 20m. He again took a left turn and walked 30m. How far and in which direction is he from his starting point?

- (a) 20m, North
- (b) 80m, North
- (c) 20m, South
- (d) 80m, South

Answer: a

Explanation:

According to the question, the direction diagram is as follows

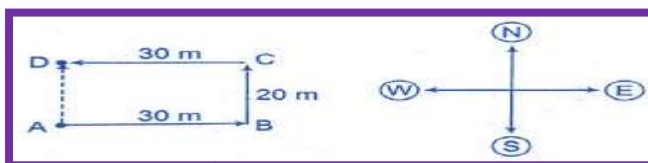

Required distance = AD = BC = 20m

So, Nikhil is 20m North from his starting point

Question35

Rakesh is standing at a point. He walks 20m towards the East and further 10m towards the South, then he walks 35m towards the West and further 5 m towards the North, then he walks 15 m towards the

East. What is the straight distance (in m) between his starting point and the point where he reached last?

- (a) 0 (b) 5
(c) 10 (d) Cannot be determined

Answer: b

Explanation:

According to the question. The direction diagram is as follows



From diagram, $AB = 20\text{m}$ $BC = HD = 10\text{m}$
 $ED = 5\text{m}$ $CD = 35\text{m}$ $HE = AF$
Required distance, $AF = HF = HD - ED$
 $= 10 - 5 = 5\text{m}$

Question 36

Anoop starts walking towards South. After walking 15m he turns towards North. After walking 20m, he turns towards East and walks 10m. He, then turns towards South and walks 5m. How far is he from his original position in which direction?

- (a) 10m, North (b) 10m, South
(c) 10m, West (d) 10m, East

Answer: d

Explanation:

According to the question, the direction diagram is as follows

A = Original position, E = Finishing point

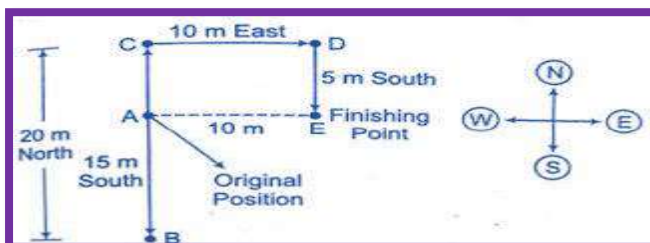

$BC = 20$, $AB = 15\text{m}$, $AC = ED = 5\text{m}$, $CD = AE = 10\text{m}$
Clearly, at finishing point E, Anoop is 10 m East from original position A.

Question 37

From a point, Rajneesh started walking East and walked 35m. He, then turned on his right and walked 35m. He, then turned on his right

and walked 20m and he again turned to right and walked 35m. Finally, he turned his left and walked 20m and reached his destination. Now, how far is he from the starting point?

- (a) 50m
- (b) 55m
- (c) 20m
- (d) 40m

Answer: d

Explanation:

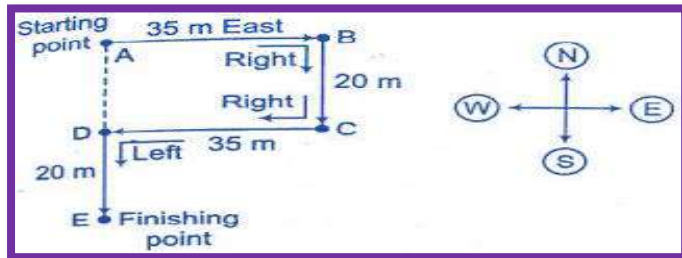

Rajneesh walked 35 m East. He then turned right i.e. facing South walked 20 m. He again turned right i.e. facing West and moved 35 m. So, now he is 20 m far from the starting point.

He then turned left i.e. facing South and moved 20 m.

So, he is in the same line from where he started and 40 m far.

Hence, D is the correct option

Question 38

A rat runs 20m towards East and turns to right, then runs 10m and turns to right, runs 9m and again turns to left, runs 5m and then turns to left, runs 12m and finally turns to left and runs 6m. Now, which direction is the rat facing?

- (a) East
- (b) North
- (c) West
- (d) South

Answer: b

Explanation:

According to the question, the direction diagram is as follows

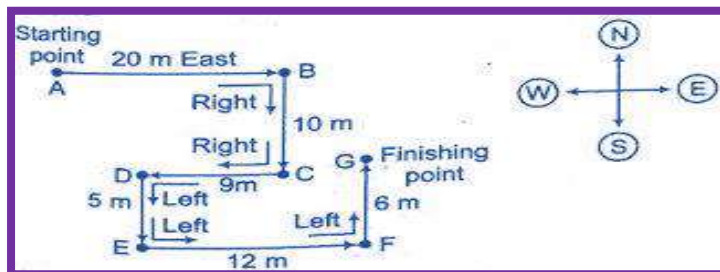

Clearly, the rat is facing North at finishing point.

Question 39

Starting from a point S, Mahesh walked 25m towards South. He turned to his left and walked 50m. He, then again turned to his left and

walked 25m. He again turned to his left and walked 60m and reached a point T. How far Mahesh is from point S and in which direction?

- (a) 10m, West (b) 25m, North
(c) 10m, East (d) 25m, West

Answer: a

Explanation:

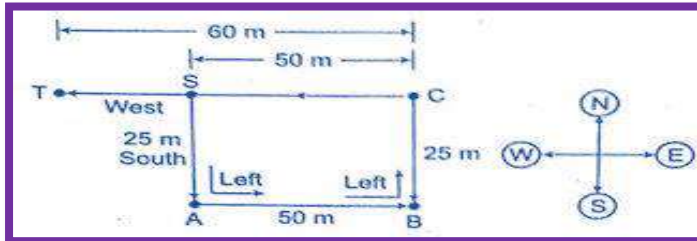

According to the question, the direction diagram is as follows

S = Starting point, T = Finishing point AS = BC = 25m

AB = SC = 50m CT = 60m

Required distance, ST = CT - SC = 60 - 50 = 10m clearly, at point T, Mahesh is 10 m West from S.

Question 40

Village Chimur is 20 km to the North of village Rewa. Village Rahate is 18 km to the East of village Rewa. Village Angne is 12 km to the West of Chimur. If Sanjay starts from village Rahate and goes to village Angne, in which direction is he from his starting point?

- (a) North (b) North-West
(c) South (d) South-East

Answer: B

Explanation:

See the image for locations of various Villages given in the question.

If Sanjay starts from Rahate and goes towards Angne, he is clearly moving in North-West direction.

option B

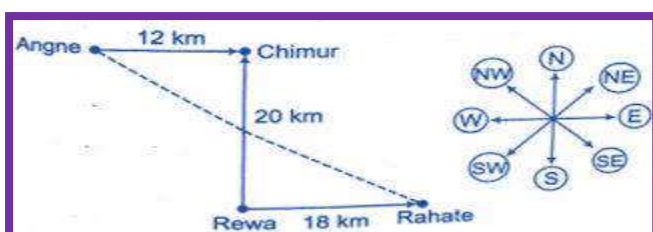

Question 41

A boy is looking for his mother. He went 90 metres in the east before turning to his right. He went 20 metres before turning to his right again to look for his mother at his uncle's place 30 metres from this point. His mother was not there. From here he went 100 metres to his north before meeting his mother in a street. How far did the son meet his mother from the startingpoint?

- (a) 110m (b) 100m
(c) 90m (d) 240m

Answer: b

Explanation:

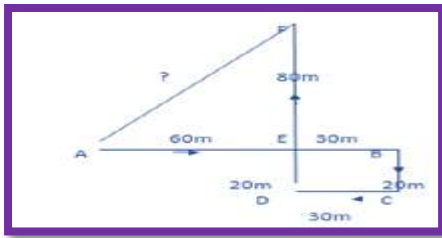

$$\frac{(80)^2 + (60)^2}{\sqrt{6400 + 3600}} = 100\text{m.}$$

Question 42

Kashmira facing towards south moved straight 8 km and from there turned to her right 90° and travelled 7 km. Then she took a 45° turn to her left and travelled 4 km. Where would she be now with respect to the startingpoint?

- (a) South (b) South-west
(c) North-east (d) South-east

Answer: b

Explanation:

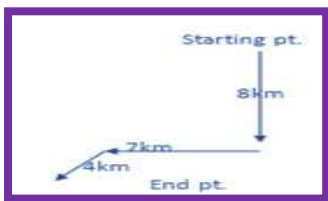

Question 43

Pinky walks 12m towards southeast and stops at point P and then she walks 24m towards west and again she walks 7m towards northwest direction and stops at point Q. Finally, she walks 5m towards east and stops at point S. She is facing which direction from startingpoint?

- (a) Northeast (b) Northwest
(c) East (d) Southwest

Answer: d

Explanation:

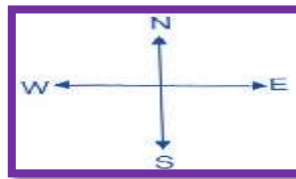
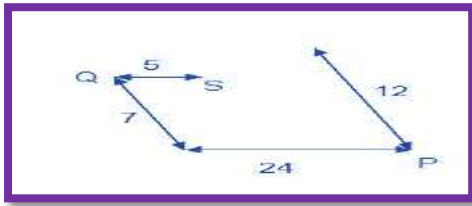

South west

Question 44

A man walks 40m towards north and he turns his left and walked 40m. He then turns his left and walked 15m. He finally turns his right and walked 20m. What is the distance he is from starting point and in which direction?

- (a) 55m, Northwest
- (b) 36m, Northeast
- (c) 65m, Southeast
- (d) 65m, Northwest

Answer: d

Explanation:

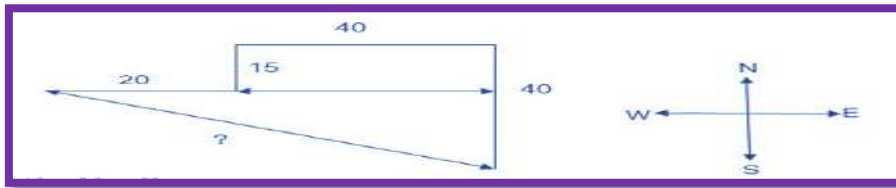

$$\begin{aligned} 40 + 20 &= 60 \\ 40 - 15 &= 25 \\ &= \sqrt{60^2 + 25^2} \\ &= 65\text{m, North West} \end{aligned}$$

Question 45

A person starts from point A, walks 5m towards south and reaches point B. He then turns left and walks 8m and reaches point C. He then takes a right turn and walks 6m. He takes a final right turn and walks 8m to reach point D. What is the distance between point C and D?

- (a) 13m
- (b) 12m
- (c) 10m
- (d) 15m

Answer: c

Explanation:

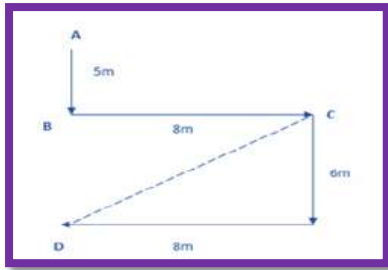

Distance between C and D = $\sqrt{(8^2+6^2)} = \sqrt{(64+36)} = \sqrt{100} = 10\text{m}$

Question 46

A car started from point P and moves towards east. After moving a distance of 30m, it took a right turn, again after moving 15m, it took a left turn, and again after moving 10m, he took a right turn. Which direction is the car facing now?

- (a) North
- (b) South
- (c) West
- (d) North-west

Answer: b

Explanation:

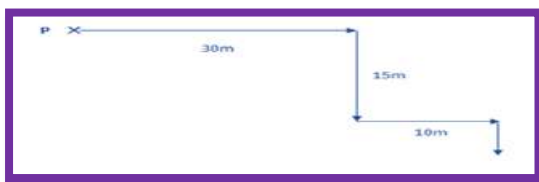

The car is facing the south direction.

Question 47

A directional post is erected on a crossing, in an accident it was turned in such a way that the arrow which was first showing east is now showing north. A passerby went in a wrong direction thinking it is east. In which direction is he actually travelling now?

- (a) North
- (b) East
- (c) West
- (d) South

Answer: d

Explanation:

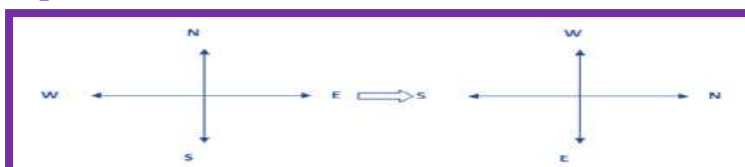

When the arrow turns, north becomes west, east becomes north, south becomes east, west becomes south. So, he travels in south direction.

Question 48

A person walks 22m towards east from point 'A' and turns his left and walks 6m. Again he turns his right and walked 7m and he reached the point 'P' after walking 6m towards his right. Finally he turns right and stop at point 'B' after walking 19m towards west from point P. What is the distance to reach the starting point from PointB?

- (a) 3m (b) 10m
(c) 4m (d) 5m

Answer: b

Explanation:

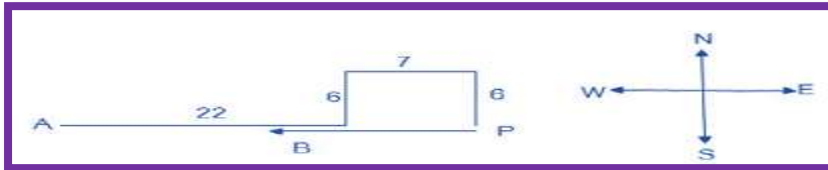

The distance to reach the starting point from PointB is 10m.

Question49

A man started walking from point A and walk towards north and stops at point B. Now he takes a right turn followed by left turn and stops at point C. He finally takes a left turn and stops at point D. Towards which direction the man has to walk from D to B, if he walks 10m before turning eachturn?

- (a) South (b) North
(c) East (d) West

Answer: a

Explanation:



Question 50

Read the following information carefully and answer the questions given below it:

- i. $M?N$ means N is to the right of M at a distance of twometre. ii. $M*N$ means N is to the North of M at a distance of two metre. iii. $M+N$ means N is to the left of M at a distance of two metre. iv. $M\%N$ means N is to the South of M at a distance of twometre. v. In each of the following questions all persons face North.

Que. If $P\%Q+R*S$ then S is in which direction with respect toP?

- (a) South-east (b) East.
(c) North (d) West

Answer: d

Explanation:

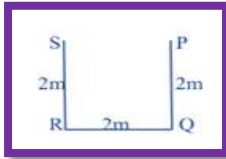

Question 51

Nakul starts walking from his office towards his house. He starts from the front gate of his office and walks 5 km, then turns left and walks 2 km, then turns left again and walks 4 km, then he turns to his right and walks 3 km, then turns left and walks 1 km and then turns to his left again and walks 4 km, then turns to his right and walks 10 km and finally turns right and walks 3 km and thus reaches the front gate of his house. If Nakul's house is facing south, in which direction did he start walking?

- (a) East
- (b) West
- (c) South
- (d) North

Answer: a

Explanation:



PAST EXAMINATION QUESTIONS:

MAY 2018

Question1

Laxman went 15. Kms to North then he turned West and covered Kms. Then he turned South and covered 5 Kms, finally turning to East he covered 10 Kms. In which direction in which he is now moving?

- (a) East
- (b) West
- (c) North
- (d) South

Answer: c

Explanation:



Question2

A man is facing East, then he turns left and goes to 10 meter then turns right and goes 5 meter then goes 5 meter to the south and from their 5 meter to West. In which direction is he from his original place?

- (a) East
- (b) North
- (c) West
- (d) South

Answer: b

Explanation:



North direction is he forms his original place.

Question3

X Walks southwards and then turns right the left and the right. In which direction is he moving now?

- (a) South
- (b) North
- (c) West
- (d) South-west

Answer: c

Explanation:



He is moving in west direction.

Question4

Raman starts walking in the morning facing the sun. After sometimes, he turned to the left later again he turned to his left. At what direction is Raman moving

how?

- (a) East (b) West
(c) South (d) North

Answer: b

Explanation:



Raman is moving now in West direction.

Question5

I stand with my right hand extended side-ways towards south. Towards which direction will my back be?

- (a) North (b) West
(c) East (d) South

Answer: b

Explanation:

I stand with my right and extended side- ways towards south. Towards west direction will my back.

Question6

You go north, turn right, then right then go to the left. In which direction are you now?

- (a) North (b) West
(c) East (d) South

Answer: c

Explanation:

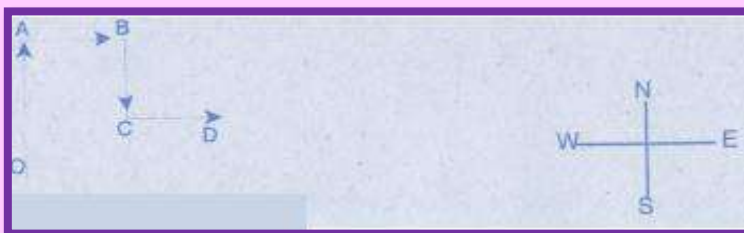

You are in East direction

NOV 2018

Question1

Six flats on a floor in two rows facing North and South are allotted to P, Q, R,

S, T and U. If Q gets a North facing flat and is not next to S. Sand U get diagonally opposite flat. R next to U gets a South facing flat and T gets a North facing flat. Whose flat is between Q and S?

- (a) T (b) U
(c) R (d) P

Answer: a

Explanation:

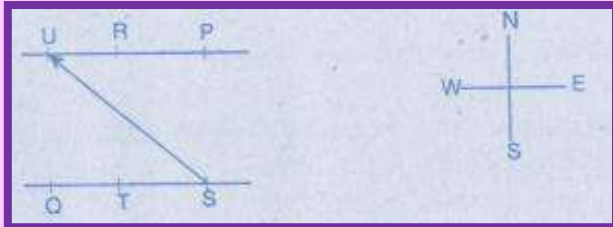

Flat 'T' is b/w Q & S

Question2

Anoop Starts walking towards South after walking 15 meters he turns towards North. After walking 20 metres he turns towards East and walks 10 meters. He then turns towards south and walks 5 meters. In which direction is he from the original position.

- (a) North (b) West
(c) East (d) South

Answer: c

Explanation:

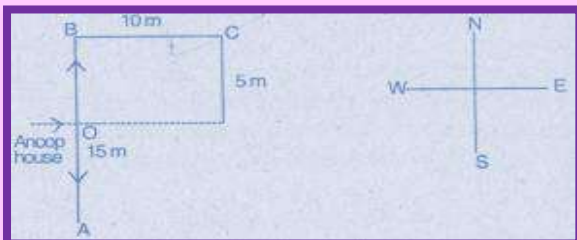

'East direction is he from the original Position'

Question3

Rahim started from point X and walked straight 5 km. West, then turned left and walked straight 2 km. and again turned left and walked straight 7 km. In which direction is he from the point X?

- (a) North-East (b) South-West
(c) South-East (d) North West

Answer: c

Explanation:

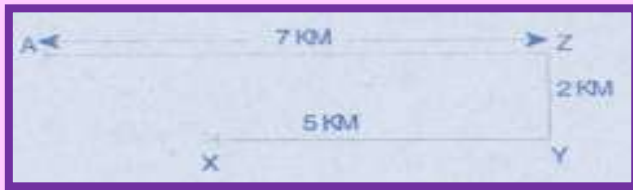

Question4

Aman started to walk East, after moving a certain distance, he turns to his right. After moving 6 me distance, he turns to his right again. After moving a little he turns now to his left currently, he is going in direction

- (a) North
- (b) West
- (c) East
- (d) South

Answer: d

Explanation:

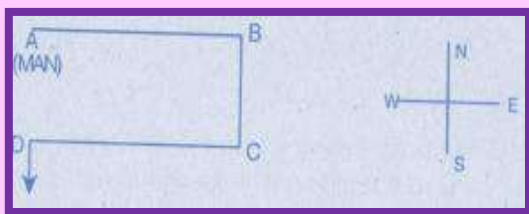

He is going in south direction.

Question5

Manu wants to go to the market. He starts from his house towards North reaches at a crossing after 30m. He turns towards East, goes 10m till the second crossing and turns again, moves towards South straight for 30m where marketing complex exits. In which direction is the market from his house?

- (a) North
- (b) West
- (c) East
- (d) South

Answer: c

Explanation:

Direction is the market from his house is east.

MAY 2019

Question1

When a person faces north and walk 25 m and she turn left and walk 20m and again turns right and walk 25m, and turns right 25m and turns right and walks 40m in which direction is he now from his starting point.

- (a) North – West
- (b) North – East
- (c) South – West
- (d) None

Answer: b

Explanation:

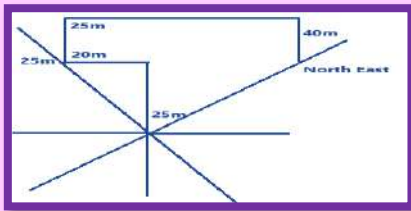

Question2

Madhuri moved a distance of 75 meters toward north. She then turned to the left and walking for about 25m, turned left again and walks 80m, finally she turned to the right at an angle of 45°. In which direction was she moving finally?

- (a) South - East
- (b) South - West
- (c) North - west
- (d) North - East

Answer: c

Explanation:

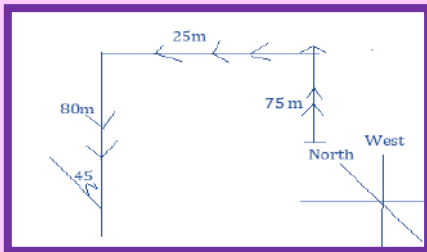

Question3

A person facing North 70° clock wise direction moving in clockwise and 300° clock wise direction. Now, in which direction he presently facing.

- (a) North-West
- (b) South-East
- (c) North-East
- (d) South -West

Answer: c

Explanation:

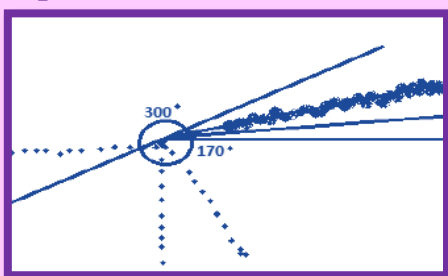

Question4

Sangeetha leaves from her home. She first walks 30 metres in north - west direction, and then 30 m in south west direction, next she walks 30 metres in south - east direction. Finally, she turns towards her house. In which direction is she moving

- (a) North West
- (c) South - East

- (b) North - East
- (d) South - West

Answer: c

Explanation:

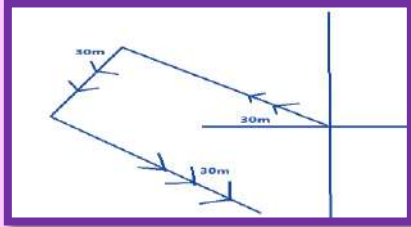

Question5

A man starts his journey facing the sun early morning. He then turns right and walks 2 km. He then walks 3 km after turning right again. Which direction was Ashok from the starting point?

- (a) East
- (b) North
- (c) West
- (d) South

Answer: c

Explanation:

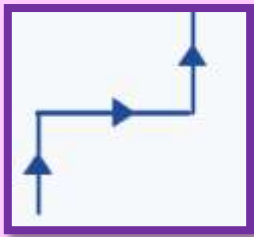

West

NOV 2019

Question1

Mohan started from a point and walked towards west. He took left to reach Sohan's house. In which direction should he move to reach his house:

- (a) North east
- (b) South east
- (c) South west
- (d) North West

Answer : (a)

Explanation:

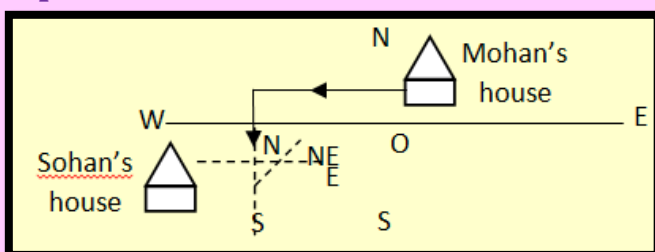

So, Mohan should move in north east direction from Sohan's house to reach his house.

Question2

A man stands on a point and starts walking towards north then turns. Left then turns right and then left in which direction he is moving

- (a) West
- (b) North
- (c) East
- (d) South

Answer: (a)

So, the man is moving in the west direction.

Question3

A man started from a point facing north then turn left and then left then right. In which direction he is facing now?

- (a) East
- (b) West
- (c) North
- (d) South

Answer: (b)

Explanation:

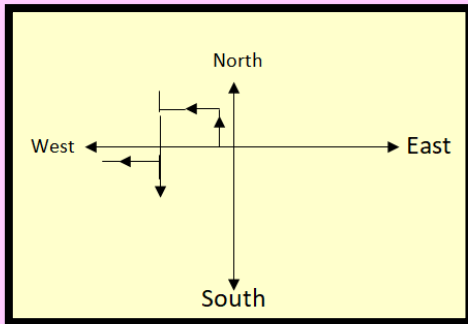

He is facing west.

Question4

Rohan driving cycle from house towards north, turn left and left again, which direction he is facing now?

- (a) East
- (b) West
- (c) North
- (d) South

Answer: (b)

Explanation:

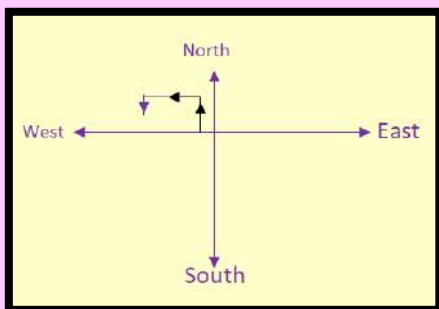

So Rohan is facing towards south.

Question 5

Sun rises behind the tower and sets behind the railway station. In which direction is the tower from railway station?

- (a) North (b) South
(c) East (d) West

Answer: (c)

Explanation:

Since the sun rises behind the tower. So tower is in east direction, railway station is in west direction since sun sets behind it. So tower is in east direction from the railway station.

DEC 2020

Question 1

Rahim faces towards north turning to his right he walks 25 mtrs he then turns to his left and walks 30 mtrs. Next he moves 25 mtrs. To his right he then turns to his right again and walks 55 mtrs. Finally he turns to the right and moves 40 mtrs. In which direction is he now from the starting point?

- (a) South - West (b) South
(c) North - West (d) South - East

Answer: d

Explanation:

Man's movement is as shown in the figure.

∴ Finally he is in south-east direction with respect to A i.e. starting point.

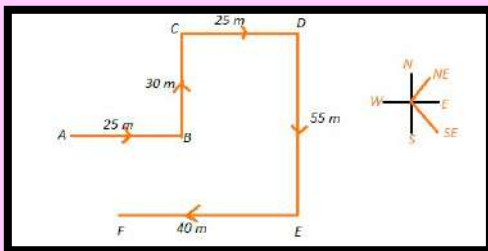

Question 2

A man can walk by having long, medium and short steps. He can cover 60 meters by 100 long steps, 100 meters by 200 medium steps and 80 meters by 200 short steps. He starts walking by 5,000 long steps, then he turns left and walk by taking 6,000 medium steps. He then turns right and walk by taking 2,500 short steps.

How far (in meters) is he away from his starting point?

- (a) 5,000m (b) 4,000m
(c) 6,000m (d) 7,000m

Answer: d

Explanation:

Square root of 7000 Step-by-step explanation: For 5000 long steps he travelled $\frac{5000}{100} \times 60$ meters then he turned left and take 6000 medium steps and travelled $\frac{6000}{200} \times 100$ meters then he turns right and travelled $\frac{2500}{200} \times 80$ meters by taking 2500 short steps. As we want to calculate distance from stating pointy It we have to consider it as right angled triangle so we get hypotenuse as square root of (4000+3000)

Question3

One day, Ram left home and cycled 10km southwards, then he turns right and cycled 5km, then he turns right and cycled 10km and then he turns left and cycled 10 km. How many kilometers will he have to cycle to reach his home straight?

- (a) 15km (b) 10km
(c) 20km (d) 25km

Answer: a

Explanation:

According to given fig.,
required distance = A+E
= 5+10
= 15 km

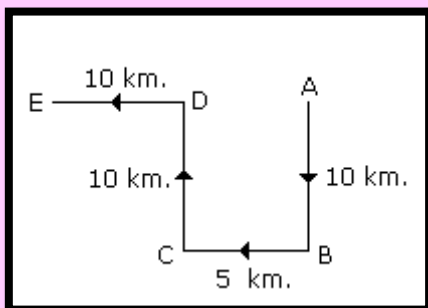

Question 4

You are facing north - east and moved forward 10ms and turned left for 7.5 m what is your position?

- (a) North from initial (b) South from initial
(c) East from initial (d) None

Answer: a

Explanation:

Clearly, The narrator starts from A, moves towards north - east a distance of 10m, upto B, turns left (90o anti clockwise) and moves 7.5 m upto C

Clearly, C lies to the north of A

Also ΔABC is right - angles at B

So $AC^2 = AB^2 + BC^2 = (10)^2 + (7.5)^2$

$$=100+56.25 = 156.25$$

$$AC= \sqrt{(156.25)m} = 12.5m$$

Thus, the narrator is 12.5m to the north of his initial position.

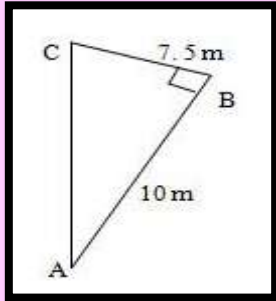

Question 5

A man is facing west. He turns 45 degrees in the clockwise direction and then another 180 degrees in the same direction and then 270 degrees in the anticlockwise director, which direction is he facing now?

- (a) South - West (b) North - West
(c) West (d) South

Answer: a

Explanation:

At starting Man facing West direction.

After turning 45 degree clock wise his direction will be North- West

After turning 180 degree clock wise in same direction his direction will be South-East

After turning 270 degree anti clock wise his direction will be South-West

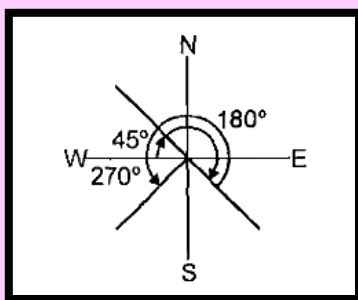

JULY 2021

Question 1

A and B start moving towards each other from two places 200m apart. After walking 60m, B turns left and goes 20m, and then he turns right and goes 40m. He then turns right again and comes back to the road on which he had started walking. If A and B walk with the same speed, what is the distance between them

now?

- (a) 80 m (b) 70 m
 (c) 40 m (d) 60 m

Answer: Options (c)

Explanation:

Distance travelled by A on road = $60 + 20 + 40 + 20 = 140$ m

Distance travelled by B on road = $60 + 40 = 100$ m

Required difference = $140 - 100 = 40$ m

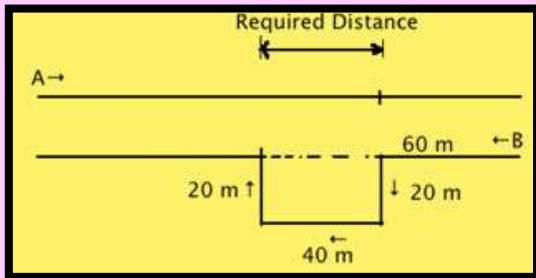

Question 2

There are four towns P,Q,R and T. Q is to the south-west of P, R is to the east of Q and south-east of P, and T is to the north of R in line with QP. In which direction of P is T located?

- (a) North (b) North-East
 (c) East (d) South-East

Answer: Options (b)

Explanation:

Consider a Cartesian plane taking positive X-axis as East and negative X-axis as West positive Y – axis as North and negative Y – axis as south.

Let us consider that P is at origin. Hence Q would be in the third quadrant; R would be in fourth quadrant because it is in the south-east of P. Finally T would be in the first quadrant as P, Q, T are on the same line. Hence T would be on North-east of P.

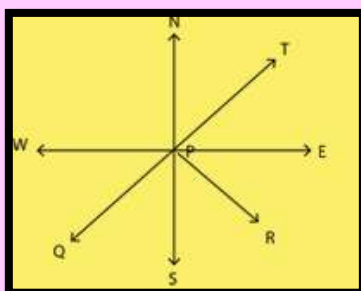

Question 3

Five friends A, B, C, D and E are staying in the same locality. B's house is to the east of A's house and to the north of C's house. C's house is to the west of D's house is in which direction with respect to A's house?

- (a) North-East (b) South-East

(c) North-West

(d) South-West

Answer: Options (b)

Explanation:

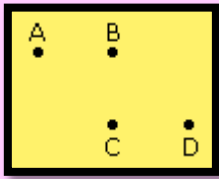

Therefore, D's house is in the South-East direction of A.

Question 4

One morning, after sunrise, Vikram and Shailesh were standing in lawn with their backs towards each other. Vikram's shadow fell exactly towards left hand side. Which direction was Shailesh facing?

(a) South-West

(b) West

(c) South

(d) East-South

Answer: Options (c)

Explanation:

Sun rises in the East in morning

Therefore, Shailesh was facing South direction.

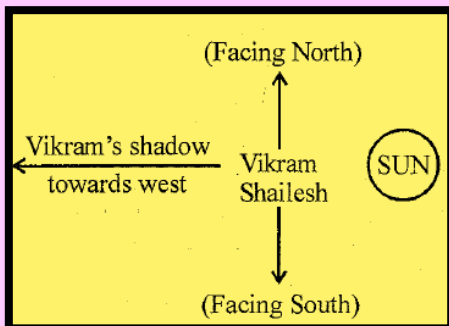

DEC 2021

Question 1

A person walks 1 km (kilometre) towards West and then he turns to South and walks this he turns 5 km. Again, he turns to West and walks 2 km. After this he turns to North and walks 9km. How far is he from his starting point?

(a) 3km

(b) 4 km

(c) 5 km

(d) 7km

Answer: c

Explanation:

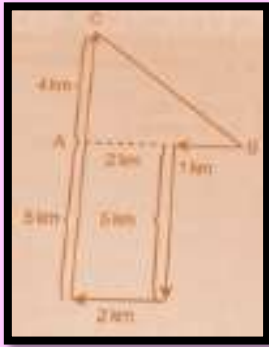

In the ABC, we need to find out BC.

As per Pythagoras' Theorem,

$$BC^2 = AB^2 + AC^2$$

$$BC = \sqrt{AB^2 + AC^2}$$

$$BC = \sqrt{(3)^2 + (4)^2} = 5$$

Question 2

Daily in the morning the shadow of a Clock Tower installed on Railway Station falls on high rise Mall and in evening the shadow of the same Mall falls on the clock tower installed on railway station exactly. So in which direction is Clock Tower to Mall?

- (a) Eastern side (b) Western side
(c) Northern Side (d) Southern side

Answer:

Explanation:

Sun rises in the East. Therefore, in the morning, the shadow of the things located in East will fall towards West and in the evening the shadow of the things located in west will fall towards East.

Here, since the shadow of the clock tower is located on the Eastern side.

Question 3

R's office is 4 km. in East direction from his home and club is 4 km in North direction from his home. On midway from office to club, R starts moving towards his home. In which direction is he facing his back?

- (a) South-East (b) North-West
(c) North-East (d) South-West

Answer: c

Explanation:



Clearly, the back of R is towards North-East.

Question 4

A man starts from a point, walks 4 miles towards North and turns left and walks 6 miles, turns right and walks for 3 miles and again turns right and walks 4 miles and takes rest for 30 minutes. He gets up and walks straight 2 miles in the same direction and turns right and walks one mile. What is the direction he is facing?

- (a) North
(b) South- East
(c) South
(d) West

Answer: b

Explanation:



Therefore, he is facing South direction.

Question 5

The hour hand of a clock is in west direction when time is 3'0 clock. What is the direction of minutes hand when time is 6:45?

- (a) East
(b) West
(c) North
(d) South

Answer: a

Explanation:



JUNE 2022

Question 1

A sign board pointing direction towards north due to heavy wind. The points of sign words shows west instead of North. If a person moves to same direction of pointer. He moves 100 meter than turn left, and moves 100 meter than again turn left and move 100 meter than he turn right & moves 100 meter. In which direction he is now?

- (a) West
- (c) North

- (b) East
- (d) South

Answer: Options (d)

Explanation:

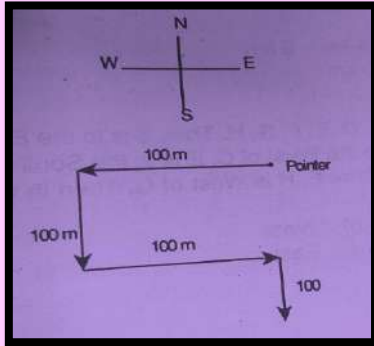

He is south direction from starting point 'Now'

Question 2

If Ramu faces West and moved 5 km in the direction then takes a left turn and moves 10 km then take another left turn and moves 15 km in same direction then moves 10 km in the north direction and reaches point A. What is distance between the starting point and A and in which direction is Ramu facing now?

- (a) 10 km, North
- (b) 5 km, South
- (c) 10 km, South
- (d) 5 km, North

Answer: Options (a)

Explanation:

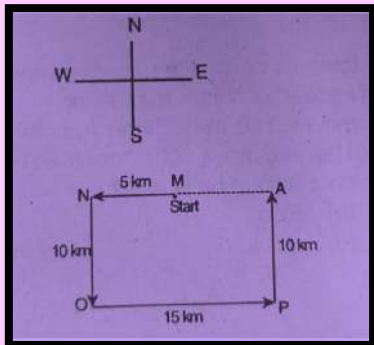

Distance b/w M and A = 15 km - 5 km

Direction → (North)

Question 3

If there are 8 polls from A, B, C, D, E, F, G, H. Then B is to the East of A, C is to the South of B, D is to the West of C, E is to the South of D, F is to the East of E, G is South of F, H is West of G. Then in which direction is H in respected to A.

- (a) North
- (b) West
- (c) South
- (d) East

Answer: Options (c)

Explanation:



'H' is the South of 'A'

Question 4

One day Ram Left home and cycled 10 km southward, turned right and cycled 5 km and turned right and cycled 10 km and turned left to cycle 10 km. How many kilometres will he have to cycle to reach his home?

- (a) 10
- (b) 20
- (c) 15
- (d) 25

Answer: Options (c)

Explanation:

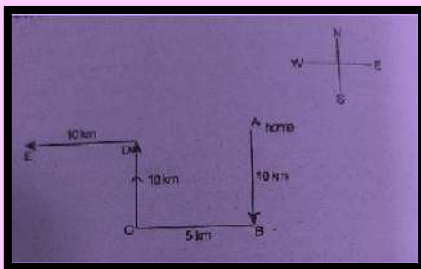

Question 5

A person facing in North moves 70° in clockwise direction. He again moved 300° in ant clockwise direction. In which direction is he facing now?

- (a) North - West
- (b) South - East
- (c) North - East
- (d) South - West

Answer: Options (b)

Explanation:

Person facing south - east

